



InBody[®] USER'S MANUAL

InBody

© 1996- InBody Co., Ltd. All rights reserved.

No part of this manual should be reproduced, stored in any retrieval system, or transmitted by any means (electronic, mechanical, photocopied, recorded, etc.) without written permission from InBody, Inc. (hereinafter InBody). No Patient liability is assumed with respect to the use of the information contained herein. This user's manual may contain misprints, which can be modified without prior notice to the readers. InBody is not liable for any damage caused by a failure to meet the requirements stated in this user's manual.

InBody Co., Ltd. [HEAD OFFICE]

InBody Bldg., 54, Nonhyeon-ro 2-gil, Gangnam-gu, Seoul 135-960 KOREA

TEL: +82-2-501-3939 FAX: +82-2-578-2716

Website: <http://www.inbody.com>

E-mail: info@inbody.com

Acknowledgements

InBody, the InBody logo, and the InBody230 are registered trademarks of InBody. The names of companies and products in this manual other than those of InBody are the trademarks of those companies. Stating the products of other companies is strictly for the purpose of providing information, not to guarantee or recommend these products. InBody is not responsible for the performance or the use of these products.

InBody reserves the right to modify the dimensions or exterior of the InBody230 to improve the quality of the product(s), without the consent of the customer.

How to use this manual.

The user's manual explains the functions of the InBody230.
Follow the instructions below for effective use this manual.

1. Please read all the instructions in this manual thoroughly before operation.
2. Fully utilize the aid materials, such as pictures and drawings, to obtain a clear understanding.
3. Before calling InBody for assistance, please refer to Chapter 4: "Problems & Solutions"
4. To purchase consumable products or optional equipments, please refer to Chapter 5: "Consumables."
5. If you have clinical issues while using the InBody230, please contact us using the E-mail address as shown below.
E-mail: info@inbody.com
6. In particular, please read the instructions and become familiar with the following indications:



DANGER

Important information to warn you of situation which might cause an imminent risk of death and/or major injury if instructions are not carefully followed.



WARNING

Important information to warn you of situations which might cause the possibility of major injury and/or damage to property if instructions are not carefully followed.



CAUTION

Important information to warn you of situations which might cause minor injury and/or damage to property if instructions are not carefully followed.



NOTE

Important helpful information for operating the InBody230.

Safety Information



DANGER

Never use this equipment in combination with the following medical electronic devices.

- Medical electronic implants, such as pacemakers
- Electronic life support systems, such as an artificial heart/lung
- Portable electronic medical devices, such as an electrocardiograph



DANGER

Do not operate within 3.5 feet from shockwave or microwave therapy equipment. Avoid simultaneously connecting patients to the InBody230 and any type of high frequency surgical equipment.



WARNING

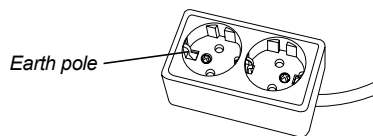

1. This product should always be placed on the ground and plugged into a secure electrical outlet.
2. Do not operate within 3.5 feet of other powered electronic medical equipment. This will result in electromagnetic interference or possibly other interferences between the InBody230 and other equipment.
3. To avoid electric shock, be sure to avoid contact between the InBody230 and any kind of external connector or other device that might be connected to a power source.
4. Do not dismantle the equipment or open the back cover. Internal parts are not for customer use. If the equipment is dismantled, the warranty is void, and service costs will be charged. If service is required, contact InBody or the supplying agency.
5. When connecting peripherals (printers and other optional devices) to the InBody230, turn on the power of the peripherals before turning on the InBody230. When turning the power off, turn off the InBody230 before turning off the peripherals. This process will minimize the harm to equipment caused by electrical shock.

-
6. The arm consists of a hand electrode, a joint and a bar. Do not force the arm strongly in the wrong direction.
The resulting damage may affect the functioning of the internal cable and circuit board.
 7. Do not operate this equipment if it has a damaged power cord or plug, if it is not working properly, or if it has been damaged.
 8. Do not immerse the power cord in water.
 9. Individuals with any kind of contagious disease or any kind of injury on the palm of their hand or sole of their foot should not come in contact with this product.
 10. Never start weight reduction or exercise therapy without instruction from a physician or a specialist. Self-diagnosis may damage your health. Consult with your physician first.
 11. This equipment is specifically designed to analyze body composition.
Use the equipment only for its intended use as described in this manual.



1. While moving, installing or using this product, be sure to protect it against any physical shock or damage. Always use the packing material and the original shipping box when moving or transporting this product.
2. Always operate this product within prescribed ranges (refer to Chapter 1, Section 3: "Installation Instruction.") of temperature, humidity, and pressure. Operating in ranges outside of those specified may affect the operation of this product and may cause malfunction.
3. Follow local governing ordinances and recycling plans regarding the disposal or recycling of device components.
4. Be careful not to spill or drop any residues of food or beverages on this product. It may cause serious damage to the electronic components.
5. Install or locate equipment only in accordance with the provided installation instructions.
6. This equipment should be serviced only by qualified personnel. Contact InBody for examination, repair or adjustment.
7. Do not touch the ports on the backside of the InBody.



NOTE

This equipment may cause the above mentioned medical electronic devices to malfunction.

This equipment may cause harmful interference to other devices in the vicinity if not installed and used in accordance with the installations.



WARNING

1. Potential electromagnetic or other interference between medical equipments and other devices being operated together in the same environmental may exert an adverse influence on functioning of the medical equipment.

Non-medical equipments not in compliance with the requirements of EN 60601-1 and EN 60601-1-2 should not be used together in the same environmental as the medical equipments.

This equipment has been tested and found to comply with the limits for medical devices in IEC 60601-1-2:2001.

These limits are designed to provide reasonable protection against harmful interference in a typical medical installation.



WARNING

2. External equipment intended for connection to signal input, signal output, or other connectors, must comply with the relevant IEC/EN standard (IEC/EN 60601-1 series for medical electrical equipment). In addition, all such connections (system) must comply with the standard IEC/EN 60601-1, Safety requirements for medical electrical systems.

Any person who connects external equipment to signal input, signal output, or other connectors has formed a system and is therefore responsible for the system to comply with the requirements of IEC/EN 60601-1-1. If in doubt, speak with a qualified technician.



WARNING

3. Do not touch signal input, signal output or other connectors, and the patient simultaneously.



However, there is no guarantee that the interference will not occur for a particular installation.

The InBody230 has been designed, manufactured, and inspected under the full quality assurance system of InBody. InBody fulfills the international standardization system, ISO 90001:2000 and ISO 13485:2003, and achieved FDA approval (Food and Drug Administration).







The InBody230 fulfills the Standards of IEC60601-1(EN60601-1), Safety of Electric Medical Equipment. In addition, the InBody230 complies not only with Level A for Noise Immunity, but also with Level A for Noise Emission by the Standard IEC60601-1-2(EN60601-1-2), Electromagnetic Compatibility Requirements.

Indicators & Safety Symbols

A. Indicators

	LCD Contrast Control
	9 pin Serial Port, Female (RS-232C)
	USB Port

B. Safety Symbols

	Dangerous High Voltage
	Danger /Warning /Caution /Note
	BF Type Equipment
 12V $\overline{\text{---}}$, 3.5A	Adapter
	Power On
	Power Off

Introducing the InBody230 - BODY COMPOSITION ANALYZER

Body Composition consists of 4 major components: Water, Protein, Minerals and Fat. These four elements are the fundamental ingredients the body is comprised of, and it is important for them to be in balance. Body composition analysis is expected to quantify and measure these ingredients.

Until recently, diagnosing obesity has focused on appearance, without considering a balanced body composition. For more reasonable health care, accurate body composition analysis must be performed first, to achieve the balance of the four major body components.

InBody has earned recognition in the international market for technical expertise demonstrated through the InBody series. Based on the experience and technology over the last 10 years, InBody has released the body composition analyzer, the InBody230.

With direct segmental measurement, the InBody230 guarantees high accuracy and reproducibility. The InBody230 yields accurate results unique to the individual, regardless of empirical estimations and reliably evaluates the effectiveness of diet control and exercise prescription. In addition, sophisticated design and measurement instructions with a flash screens allow for convenient use.

InBody is committed to providing advanced equipment to promote good health and a long life.



Kichul Cha, CEO

Contents

How to use this manual	iii
Safety Information	iv
Indicators & Safety Symbols	viii
Introducing the InBody230 –Body Composition Analyzer	ix

Chapter 1 Installation & Maintenance

1. Contents of the box	1-1
2. Exterior & Functions	1-3
3. Installation Instructions	1-10
4. Transportation	1-14
5. Repacking	1-15
6. Maintenance	1-18

Chapter 2 Management & Results Description

1. Cautions before Measurement	2-1
2. Exterior and Function of Keypad	2-2
3. Power Connection & Getting Started	2-4
4. Initial Screen	2-5
5. Personal Profile	2-6
6. Proper Posture	2-8
7. How to Operate the Equipment	2-11
8. Results	2-15

Chapter 5 Consumables

1. Consumables	5-1
2. Options	5-2

Chapter 3 Setup Establishment

1. How to Modify Settings	3-1
2. Setup Menu	3-2
3. Quick Setup	3-6

Chapter 4 Problems & Solutions

1. Error Message	4-1
2. Troubleshooting	4-2
3. Frequently Asked Question (FAQs)	4-5
4. Customer Service Information	4-7

Appendix

1. More about the InBody230	Appendix-1
2. Classifications	Appendix-3
3. Specifications	Appendix-4
4. Worldwide Patents	Appendix-5
5. Manufactures Warranty	Appendix-6



Chapter1 Installation and Maintenance

1. Contents of the Box
2. Exterior & Functions
3. Installation Instructions
4. Transportation
5. Repacking
6. Maintenance

1. Contents of the Box

When opening the box, check to make sure of all the following items are included.

A. Product Units

- 1 InBody230
- 2 InBody230 Quick Installation Guide
- 3 InBody230 Poster 1 EA
- 4 User's Manual CD
- 5 Adapter (12V, 3.5A) 1EA
- 6 Power Cord (AC 250V 10A 1.8m) 1EA
- 7 Result Sheet Box 1Box (optional)
- 8 Thermal Printer 1EA (optional)
- 9 SD400 (optional)
- 10 Serial Gender (optional)

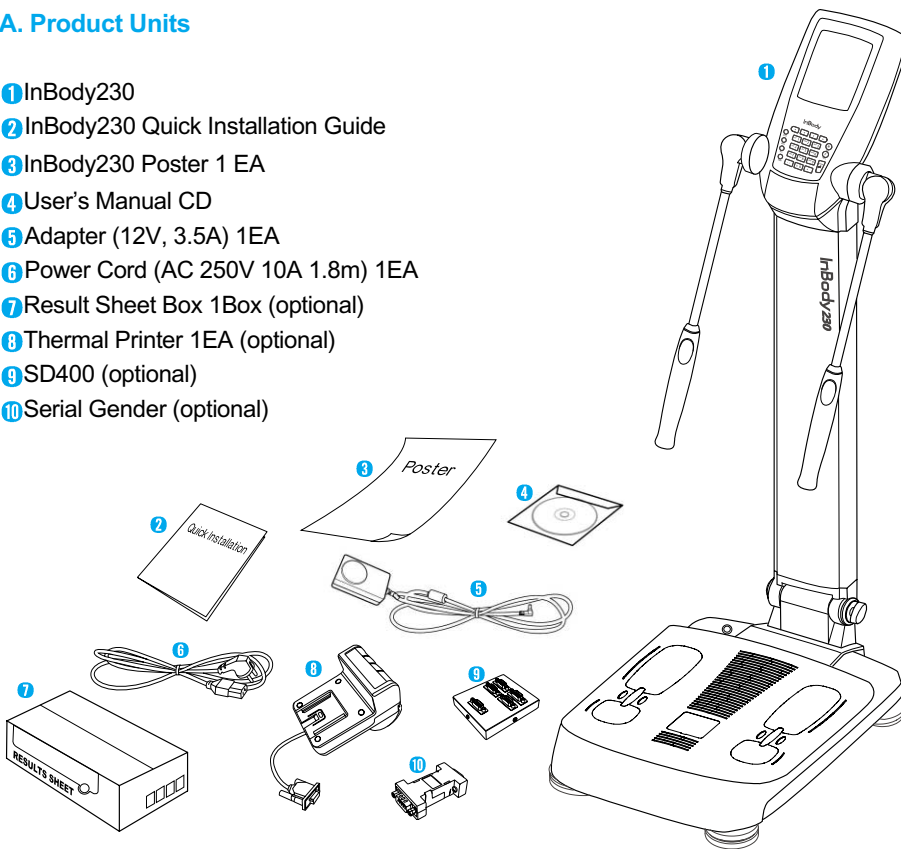

1. USB Cable is to be purchased separately for connecting the printer.

2. The printer is needed for printing the result sheets.

Please check the compatibility of the printer with InBody.

B. Package

1) Package Box

Box size: 480(W) X 940(L) X 340(H); mm 1 EA

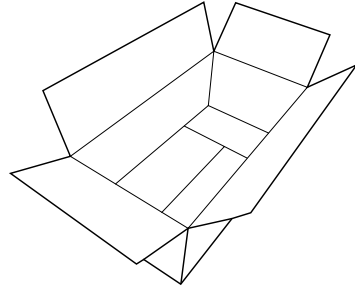

2) Packing Pad

① Top Pad 1EA

② Bottom Pad 1EA

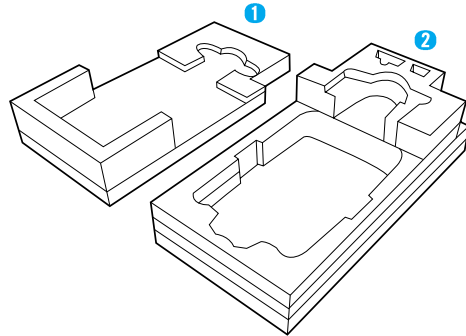

To prevent physical shock, use InBody's packing material when shipping or transporting the equipment. Refer to this Chapter, Section 4: "Transportation."

2. Exterior & Functions

Individual part identification and functions with schematic sketches are provided below. Please inspect each component of the InBody230 before installation to ensure there are no scratches or damage.

- A. Operation Part
- B. Upper Part
- C. Lower Part
- D. Rear Part

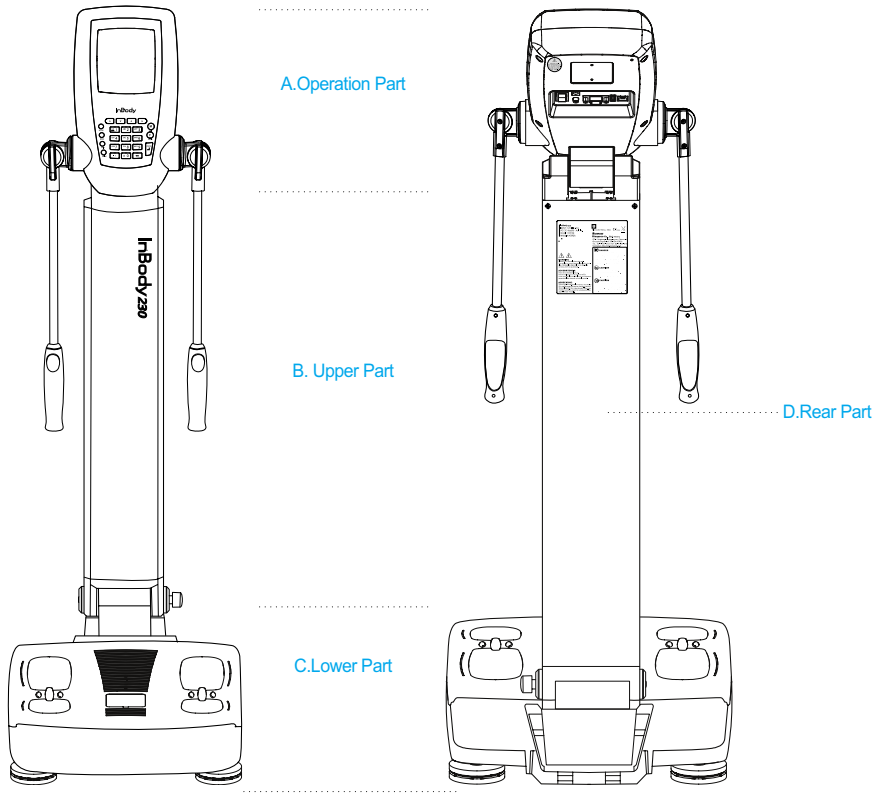

A. Operation Part

- (1) LCD Monitor (320 X 240 color STN LCD)
This displays the analysis procedure, messages and results.
- (2) Key Pad (23 buttons)
The keypad is divisible into input buttons and function buttons. These are used to input data required for body composition analysis, to set up the operating environment and to print out test results.

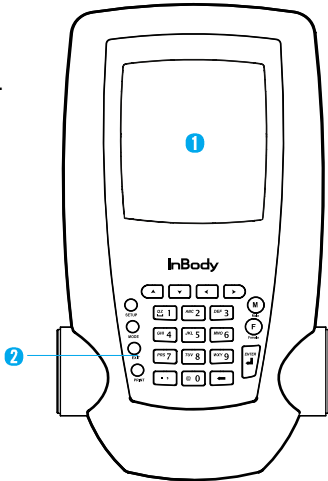

B. Upper Part

- (1) Thumb Electrode
Activated by making contact with the thumb, thus allowing current to flow through the body during measurement.
- (2) Palm Electrode
Activated by wrapping the palm around the electrode, thus allowing current to flow through the body during measurement.
- (3) Hand Electrode Joint and Hand Electrode Bar
Supports Hand Electrode and contains electric cables.

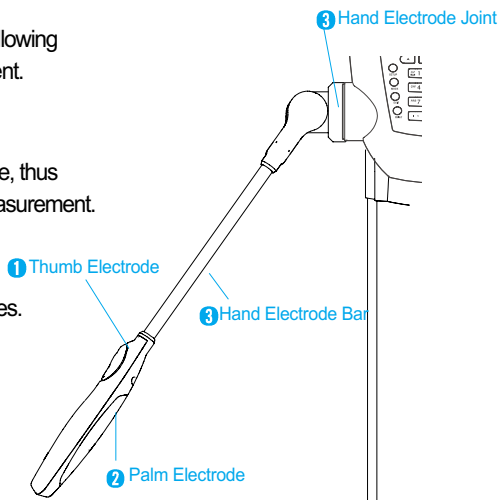

(4) Body Stand

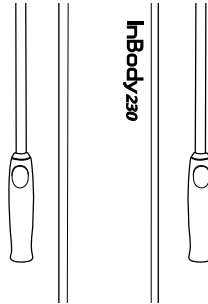

C. Lower Part

(1) Front Sole Electrode

Activated by placing the fore-foot directly on the front sole electrode. This allows the current to flow through the body.

(2) Rear Sole Electrode

Activated by placing the heel of the foot directly on the rear sole electrode.

(3) Base Frame

The loadcell, which measures body weight, is underneath the Base Frame.

(4) Joint Frame

Connects upper part and lower part.

(5) Joint Screw

Used to fix the stand after raising it.

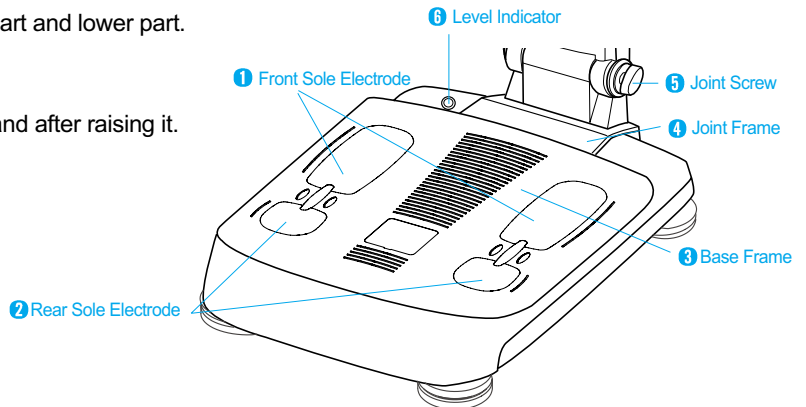

(6) Level Indicator

Used to level the InBody230 by means of a view glass and bubble alignment.

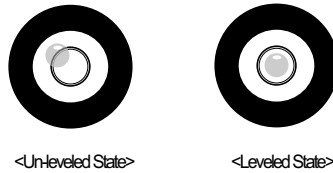
**(7) Level Screws**

There are 4 leveling screws that support the equipment. Leveling screws are designed to be turned by hand, so you can easily adjust the balance of the equipment.

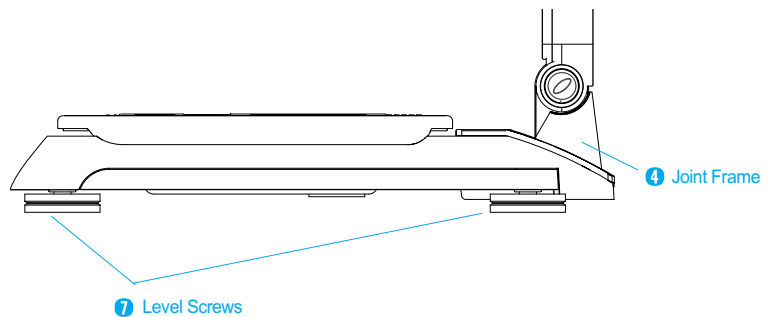

D. Rear Part

(1) Back Cover

Only qualified personnel are allowed to remove the back cover.



<Warning sticker>

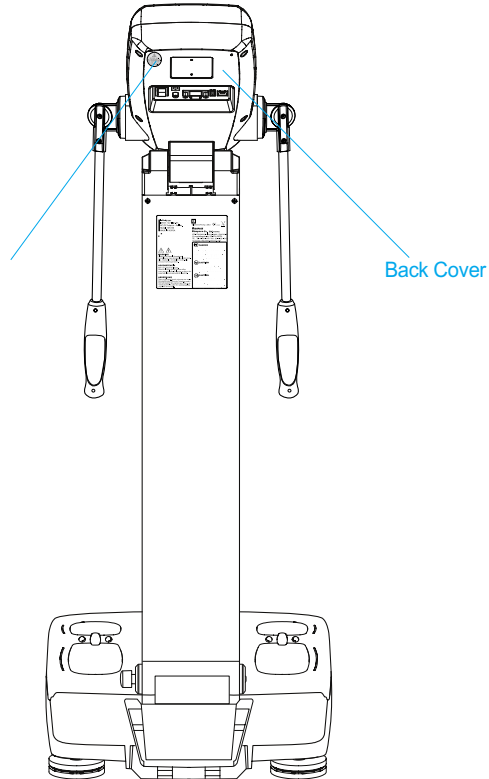

Do not dismantle the equipment or open the back cover. Internal parts are not for customer use and it may cause electric shock. If the equipment is dismantled, the warranty is void, and service costs will be charged.

(2) Control & Connection Unit

Connects to peripherals such as a PC or a printer for data transmission.

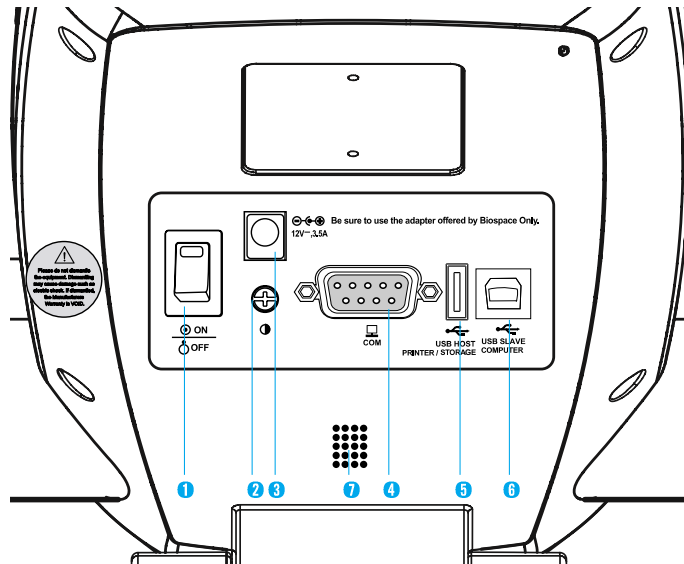

1 Power Switch

Power the InBody230 on/off.

2 LCD Bright Control

Used to adjust LCD brightness. Turn left to brighten and turn right to darken.

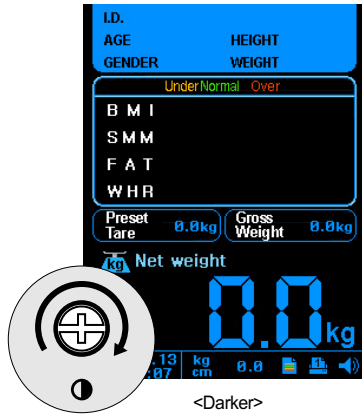

3 Power Input Port

Used to connect the power adapter.

4 9pin Serial Port, Female (RS232C)

Used to connect optional devices such as thermal printer or blood pressure monitor. Using SD400(Serial Distributor) provided by InBody, the maximum of 4 devices can be connected at once.

5 USB Host Port

Used to interface with a USB printer or a USB Storage Device.
You can use either of the two USB ports interchangeably.

6 USB Slave Port

Used to connect with a PC using Lookin' Body.



CAUTION

Use only the power cord provided by InBody to connect to the power port.



CAUTION

When you use the adapter cable, insert the adapter cable tightly into the InBody230.



NOTE

Including the optional equipment, only the peripherals provided by InBody can be connected to the InBody230. For any inquiry about peripherals, contact InBody.

(3) Speaker

A signal sound informs users of status such as process or completion of measurement.

3. Installation Instructions

A. Workplace Requirements

- (1) Location: Indoor only. Any outdoor area where the equipment is to be located should meet all the environmental requirements.
- (2) Operation environment: 50 ~ 104 °F (10 ~ 40 °C), 30 ~ 75% RH
- (3) Optimum pressure: 70 ~ 106kPa
- (4) Adapter: Power Input 100-240V, 50/60Hz, 1.2A Power Output DC 12V, 3.5A

B. Note on Unpacking & Assembling

Be sure to read these suggestions carefully before assembling.

- (1) Place the equipment on the level ground.
- (2) Don't move by holding the hand electrode joints or control part with LCD.

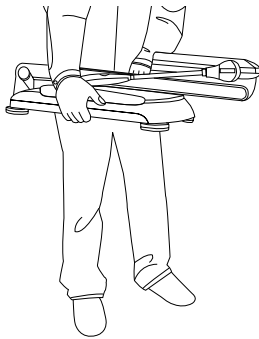

<Correct>

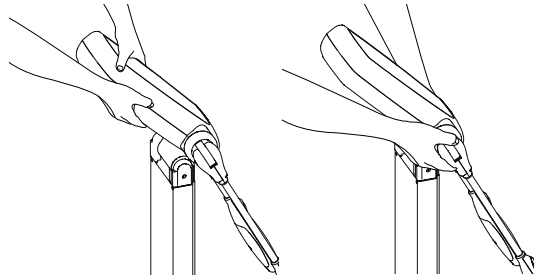

<Incorrect>

C. Unpacking & Assembling

(1) Unpack the box and remove the top pad.

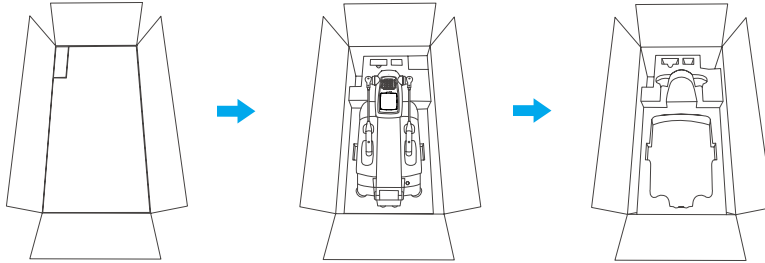

(2) Place the equipment horizontal to the ground.

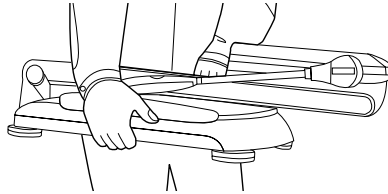

(3) Erect the stand of the equipment carefully until it stands upright. Tighten the joint screw to the right pushing it as below.

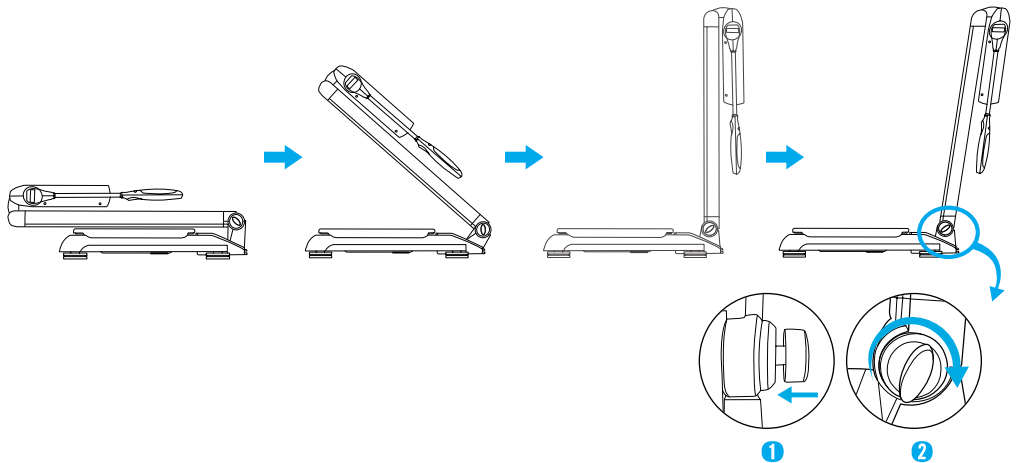

(4) Raise the head part upward.

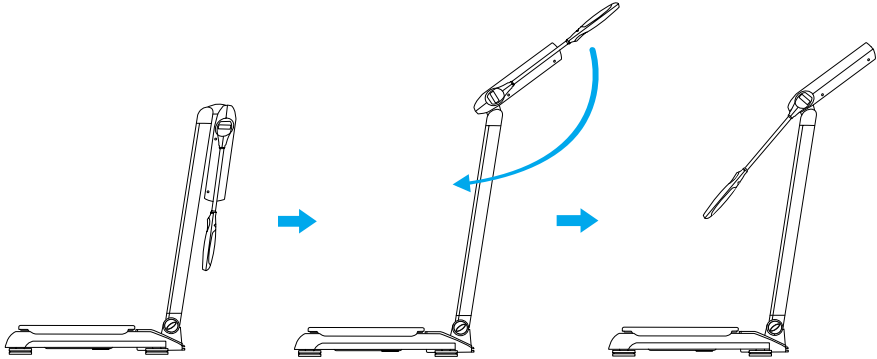

(5) Level the InBody230 using the leveling screws and level indicator. Four leveling screws are located under the lower section. The level indicator is located at the upper-left of the joint frame.

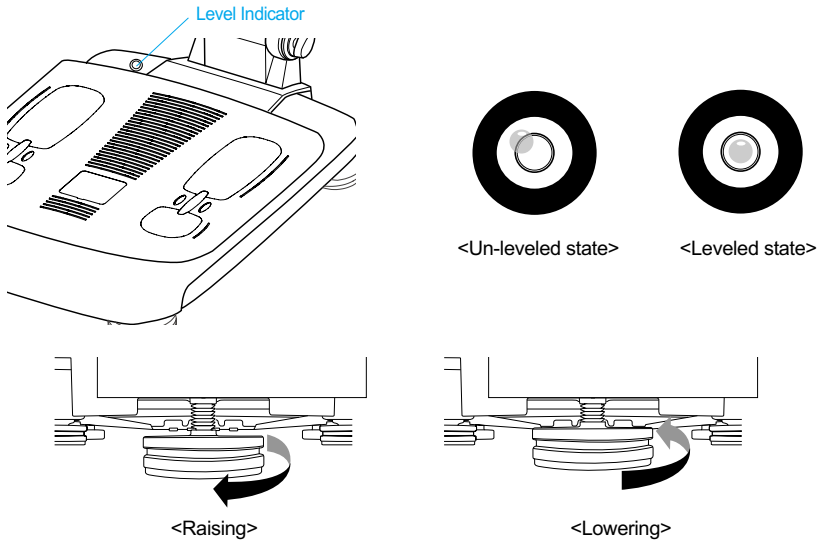



Be careful not to hurt your fingers on the edge of the base frame when handling the screws.

D. Powering

- (1) Connect the adapter cable to the power input port.
- (2) When the system switch is turned on, there is a signal sound and the InBody230 logo is displayed on the LCD.
- (3) Self-calibration will last about 15 seconds.
- (4) When self-calibration finished, the InBody230 is ready for measurement.



Do not touch the base frame when turning on the machine and while it is warming up. During self-calibration, the loadcell inside the base frame is calibrated under a zero weight condition. Applying pressure or weight to the base frame during self-calibration will result in an inaccurate calibration.



When connecting peripherals (printers and other optional device) to the InBody230, turn on the power of peripherals before turning on the InBody230. When turning the power off, turn off the InBody230 before turning off the peripherals.

4. Transportation

If it must be transported, be extra careful to ensure safe handling. The following are some tips for safety transporting the InBody230:

- (1) Before transporting the InBody230, turn off the power switch and unplug the adapter.
- (2) Be careful not to damage the hand module.
- (3) After moving the InBody230, ensure that it is placed horizontal to the ground.

A. Environmental Requirements

- (1) Optimum Temperature: $-4^{\circ}\text{F} \sim 104^{\circ}\text{F}$ ($-20^{\circ}\text{C} \sim 40^{\circ}\text{C}$)
- (2) Relative Humidity: 10% ~ 95%RH
- (3) Optimum Pressure : 50kPa ~ 106kPa

B. Transporting Before Installation

Before installation, the InBody230 is shipped in the box designed by InBody. For safety, have two people move it by holding both sides or used handling equipment such as a cart or dolly.



CAUTION

Be careful with fragile freight. The package has fragile operation parts including LCD, which has the sign on the box



CAUTION

After relocating the InBody230, make sure it is level again. Inaccurate leveling will affect accuracy of individual weight measurements.

5. Repacking

Be sure to turn off the power switch and unplug the power cable before repacking. Be careful to avoid severe physical shock, jarring or other damage while repacking, especially with regard to the arms and foot electrodes.

(1) Turn off the power switch.

Remove all cables connected to the InBody230.

(If a thermal printer is attached to the unit, remove the thermal printer first.)

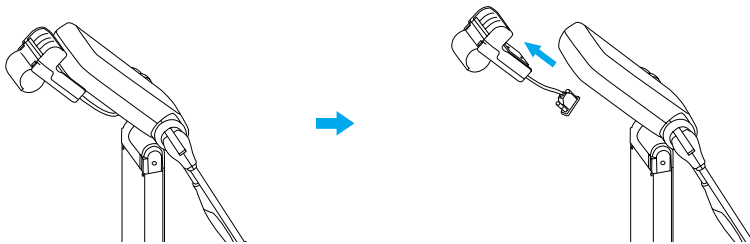

(2) Raise the hand electrodes and make parallel with the equipment's head.

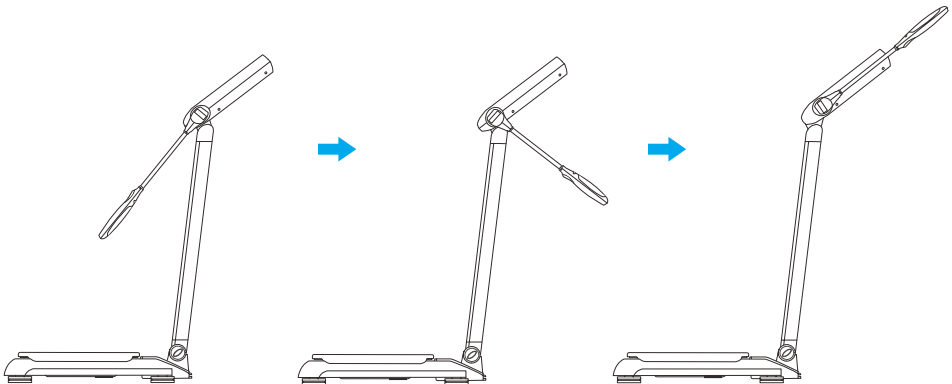

(3) Step onto the foot board and slowly fold the head part with hand electrodes until it reaches to the back of the equipment.

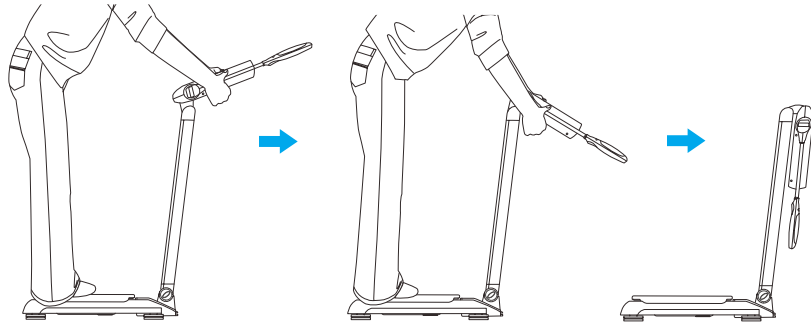

(4) Loosen the joint screw to the left and fold the head and stand towards the foot board.

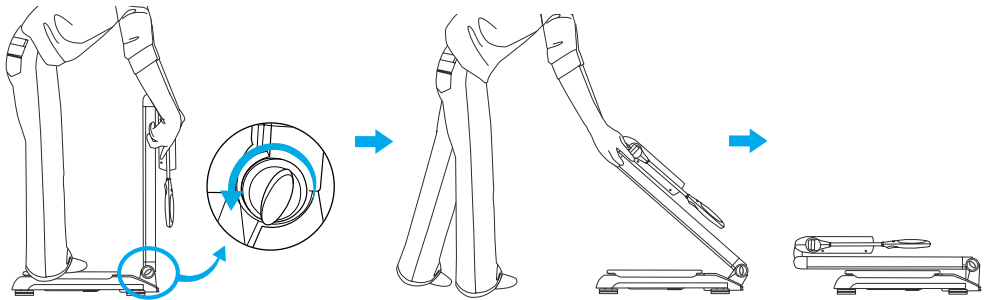

For the InBody box users

(5) Put the equipment in the box. Place the pads in position as illustrated below.

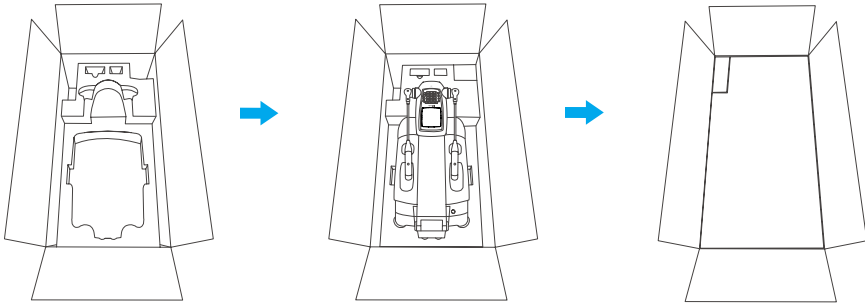

(6) Seal the box with a tape

For the InBody bag users

(5) Put the equipment in the bag as illustrated below.

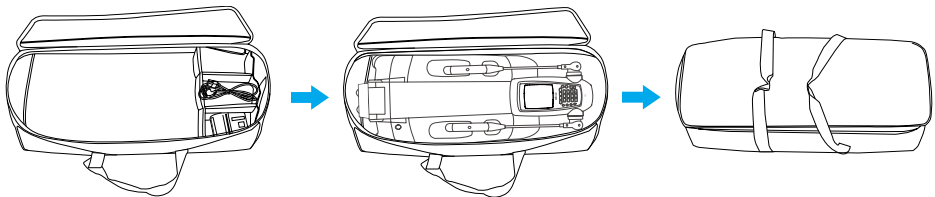

6. Maintenance

- (1) After usage wipe electrodes with a wet tissue (also known as wet naps, surface wipes, anti-bacterial tissues, etc.). Wet tissues can be purchased at any local store.
- (2) Handle the arms with care. Never apply excessive stress near the hand electrode joint. The damage caused by misuse may affect the function of the internal cable and electric board.
- (3) Do not place anything on the base frame nor apply any pressure onto it when the InBody230 is not in use.
- (4) When the InBody230 is not in use for a period longer than one day, unplug the adapter.
- (5) Do not move or relocate the InBody230 while the power is on.
- (6) Do not drop food or drinks on the equipment.
They may affect the electrical parts in the equipment or cause damage.
- (7) Once a week, wipe the exterior sides of InBody230 with a dry towel. In particular, clean the LCD monitor, softly with care not to scratch the surface.
- (8) Follow local governing ordinances and recycling plans regarding disposal or recycling of device components.



Chapter 2 Management & Results Description

1. Cautions Before Measurement
2. Exterior and Function of Keypad
3. Power Connection & Getting Started
4. Initial Screen
5. Personal Profile
6. Proper Posture
7. How to Operate the Equipment
8. Results

1. Cautions Before Measurement

To observe changes of the human body through body composition analysis, it is crucial to perform the analysis each time under the same conditions, temperature, posture, etc. Bear in mind, the following factors affect the result of body composition analysis, and as a result, affect the reproducibility of analysis.

- (1) Do not exercise or perform any physical tasks before testing. If an examinee has already been physically active, a temporary change in body composition will result.
- (2) Do not eat before measurement.
If an examinee already ate, wait 2 hours for digestion.
- (3) Do not take a bath or shower prior to measurement.
Perspiring (sweating) that occurs that also results in a temporary change in body composition.
- (4) Perform the measurement under normal temperature conditions 68~77 °F (20~25 °C).
If the ambient temperature is too high or too low, the human body responds, resulting in temporary changes in body composition.
- (5) Perform the measurement after urination or excretion, if possible. Residues inside the human body are interpreted as fat mass. Waste in the body means the analysis will be less accurate.
- (6) Measurement should be done before mid-day. In the afternoon, after being mobile all day, more body water will accumulate in the lower body, yielding an unequal distribution.

2. Exterior and Function of Keypad

Keypad is located below the display screen.

It can be distinguished into 2 categories by their functions.

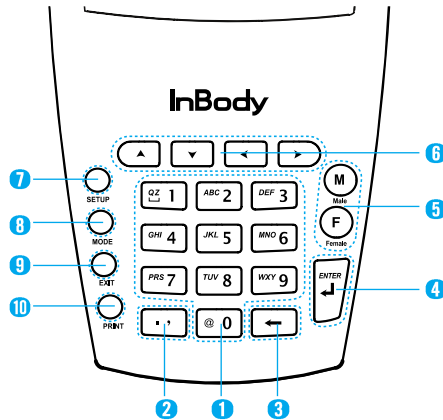

A. Input Button

(1) Number Button (0~9) / Alphabet Button (A~Z)

The input buttons are used to enter numeric and character data such as the patient's age, height and I.D. With each button press, numbers or alphabets are displayed in the sequence shown on the keypad. For instance, when press the button 2, you will see a set of numeric and character representations assigned to the button showing up in the pre-determined order of 2, A, B and C.

(2) Point / Comma Button

These buttons are used to enter a decimal point and height, age, I.D. and weight.

(3) Backspace Button

Used to delete entered data.

(4) ENTER Button

This button is used when data input is finished or to move on to the next item, or to store modified values at Setup menu.

(5) Gender Selection Button

It is used as gender input button when entering personal profile. (F : female, M : male)

B. Function Button

(6) Direction Button

The direction buttons consist of up, down, left and right buttons.

(7) SETUP Button

Used to update or modify the user environment.

(8) MODE Button

MODE button is used to set “Quick Setup” for the unit, results sheet, etc. at the initial screen. Refer to “Chapter 3. Setup Establishment” for the instructions for quick setup.

(9) EXIT Button

EXIT button is used to stop the process that is in progress or go back to the previous process.

(10) PRINT Button

You can print out an extra result sheet of the last tested examinee when you press PRINT button at initial screen. Unless another examinee steps on the base frame and completes the measurement, the last data will not be deleted and you can keep printing it.

3. Power Connection & Getting Started

- (1) Connect the adapter cable to the power input port.
- (2) When system switch is turned on, the screen is displayed as illustrated below and starts warming-up by itself. The warming-up lasts for about 15 seconds.
- (3) During warming-up, InBody230 processes the self-testing, zero point setup for the scale, and adjustment of the internal circuit. Also, it checks the usage status of the peripherals registered in Setup menu and displays it on the state window of the screen.

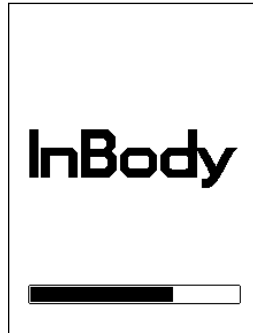

- (4) As warming-up ends and the current setting status appears, it becomes ready for the measurement with the signal sound.

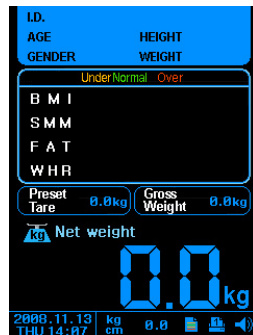

WARNING

When connecting peripherals (printers and other optional device) to InBody230, turn on the power of peripherals before turning on InBody230.

When turning the power off, turn off InBody230 first before turning off the peripherals. This process will minimize harm to the equipment caused by electric shock.



NOTE

Do not touch the base frame when turning it on and during warming-up.

Applying pressure or weight to the base frame during warming-up will result in an inaccurate calibration. And the measurement may be inaccurate.

4. Initial Screen

The initial screen of InBody230 consists of various items for both examinee and user's convenience. It can be distinguished into 4 categories as shown below.



(1) Personal Information Window

This is for I.D., age, height, gender and weight.

(2) Information Window

This area will display the process and completion of the measurement providing helpful and specific information for the examinees and the users.

(3) Analysis Results Window

Before printing out the results, you can check the key figures on the window. All figures shown in the window will be printed on the result sheet.

(4) Lower Menu Bar

The lower menu bar shows setting options registered in the InBody230 such as the current time, peripherals, units, results sheet, and sound setup.

5. Personal Profile

Age, height, weight and gender are essential information for body composition analysis. InBody230 analyzes the measurement results based on the input data. To reduce errors and acquire more reliable results, input examinee data after reading the following carefully.



- (1) I.D. (permitted range: 20 Characters)
Use number buttons to enter I.D. With each button press, numbers or alphabets are displayed in the sequence shown on the keypad.
- (2) Age (permitted range: 3 years ~ 99 years)
Use number buttons to enter age. If an examinee's age is less than 18, it is possible to input down to one decimal place for more accurate results. The decimal digit represents the number of months elapsed since the last birthday and should be decimal expressions of a fractional number with the denominator of 12. For example, the 16.5 years old can be translated into 16 years and 6 months old (6 months/12 months=0.5).
- (3) Height (permitted range: 85cm ~ 220cm / 2ft. 9.5in. ~ 7ft. 2.6in.)
Press EXIT/MODE button first to select the unit you want to use, and enter height using number buttons. If the chosen unit is 'cm', it is possible to input down to one decimal place. If the chosen unit is ft/in., it is possible to input one digit of fixed number for ft., and down to one decimal place for in.
- (4) Gender
You can select the gender by using the M/F icon or press Gender on the top right screen next to weight.

(5) Weight (permitted range: 10kg ~ 250kg / 22 lbs. ~ 551 lbs.)

The measured weight is automatically added to the weight column. You can change the units by pressing Unit in the lower menu bar. When the unit is changed the weight will change automatically. It is also possible to adjust the weight to account for clothing weight and accessories. To perform this option, enter the setup mode on the lower bar menu and press 'Others.' Using the Up and Down arrow keys, you are able to adjust the weight.

6. Proper Posture

Proper posture is essential to achieve reliable results and high reproducibility. To minimize errors and improve reliability, keep the following in mind.

A. How to hold the hand electrodes

- (1) Make parallel, flat contact with four fingers on the surface of the electrode.
- (2) Place thumb on the electrode pad on the top surface of the handle. Touch lightly, do not press with nails, and do not press down too hard.
- (3) When holding the grips, make sure your thumbs are covering the circular electrodes and hold them with the rest of your hands.

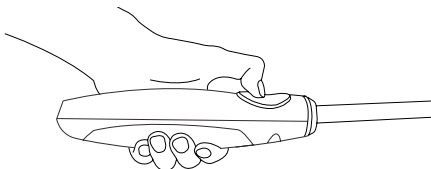

<Wrong posture>

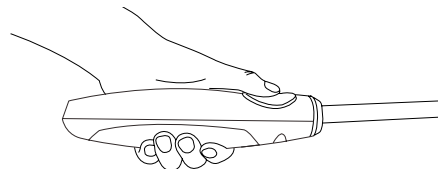

<Right posture>



NOTE

Do not press the electrodes with the fingernails: fingernails may damage the electrodes and cause inaccurate results.

B. How to stand on foot electrodes

- (1) Bare feet must be in contact with the electrode foot pads.
- (2) First, place the heel on the circular electrode.
- (3) Place sole on the elliptical electrode surface.

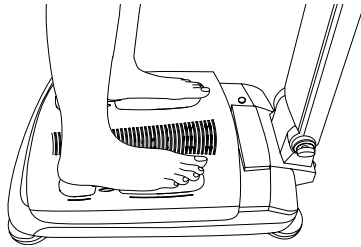

<Right posture>

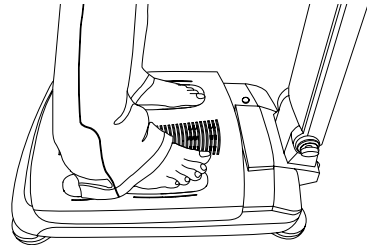

<Wrong posture>



NOTE

Do not allow pants to disturb contact between the heels and the electrodes.



NOTE

If the foot is exceptionally small, place it between the electrodes, ensuring that it makes contacts with both sets of electrodes.



NOTE

Measurements may not be possible due to hardened skin on the palm or sole. In this case, wipe the palm and sole with a wet tissue before measuring.



CAUTION

Be careful not to spill water on the electrodes. Excessive water may cause corrosion or other problems.

C. Body Posture

The proper body posture is a normal standing position with the arms and legs extended. For accurate results, please take off heavy clothes and accessories.



- (1) Avoid direct contact between the arms and the body at the armpit and between the legs at the crotch. It is recommended to stretch your arms about 15 degrees off the body during the analysis.

- (2) The examinee should remain relaxed and avoid straining or moving the body during the analysis.



NOTE

When the examinee cannot maintain proper posture during the analysis, an assistant may be required to ensure proper posture. The assistant or technician must take care not to inadvertently make skin contact with the examinee. InBody230 cannot be performed if a examinee is missing a hand, a thumb or a foot.

7. How to Operate the Equipment

The following procedure is based on the initial setting of the InBody230. If a examinee steps down from in the InBody230 during measurement the procedure is automatically cancelled.

- (1) Confirm the InBody230 is ready for measurement. If it is ready, the following screen is displayed.

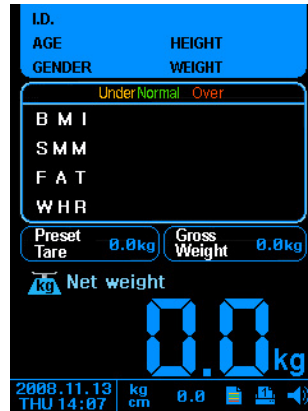

- (2) Remove heavy clothes and accessories to get the examinee's net weight.
- (3) Stand on the base frame of the InBody230. Be sure to match the examinee's heels with the heel electrodes and examinee's soles with the fore-foot electrodes. Bare feet must contact the sole electrodes. When a examinee steps onto the machine, the screen will display that individual' s weight. While the machine is measuring weight, let the hands hang naturally and stand still. After slight fluctuations, the number will settle at the examinee's correct weight. The weight value is automatically shown in the Weight column. If the examinee wants to be re-measured, the examinee has to step down from the base frame of the machine and step up on the base frame again.

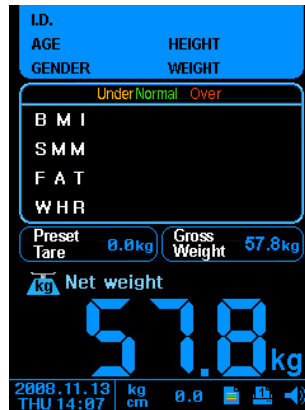

- (4) The examinee data screen will be displayed. Input I.D., age, height, gender and weight using buttons on keypad and press ENTER button. Then entered values will be added on the personal information window.
- (5) An examinee must assume the proper posture. The InBody230 checks the posture continuously. Press ENTER to start the measurement. Once measurement is started, the examinee should maintain the posture until completed.

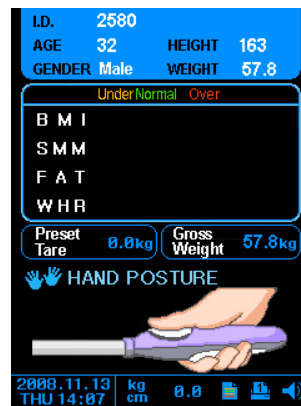
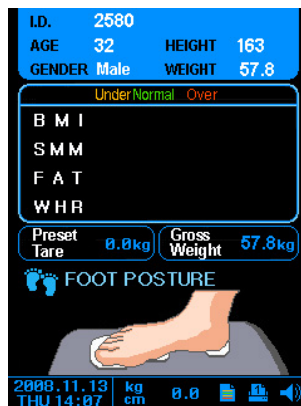



If the entered data is out of the acceptable data range, the Error Message will pop up on the monitor. Enter the examinee's data again. Refer to Section 5: "Personal Profile" for the acceptable range of each data.

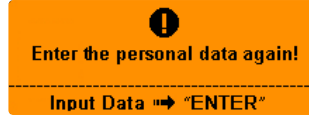

Measurement may not take place if the palm or sole are too dry or have hardened skin. In this case, wipe the palm and sole with a wet tissue before measuring.



- (6) During measurements, the InBody230 displays the results of the examinee's body composition analysis. The measurement takes approximately 30 seconds.

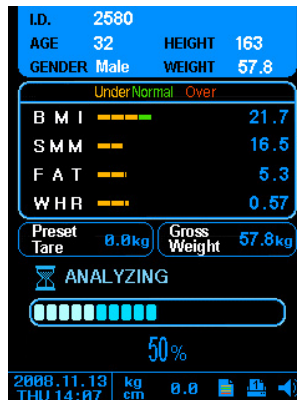

- (7) When the measurement is finished, the completion message appears in the information window with a signal sound.

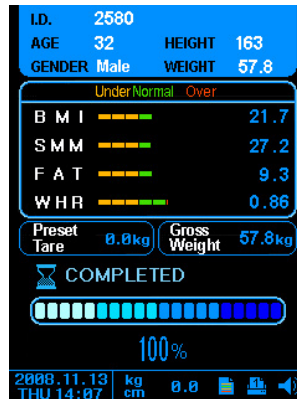

- (8) Return each hand electrode back to its original position, and step down from the base frame.



Do not turn the arm bar by force. If a bar is twisted, the InBody230 may malfunction because important cables are located inside of the hand electrode bars.

- (9) When a printer is connected, it automatically prints the result sheet.
Then the InBody230 goes back to the initial screen. If you want an additional copy of the result sheet, press 'PRINT' button.

8. Results

A. Result Screen

During measurement, the InBody230 display information of a examinee's body composition on the LCD. The results are shown on the LCD while a examinee is standing on the machine. As soon as the examinee steps down, it goes back to the initial screen, and the InBody230 is ready for measurement again.

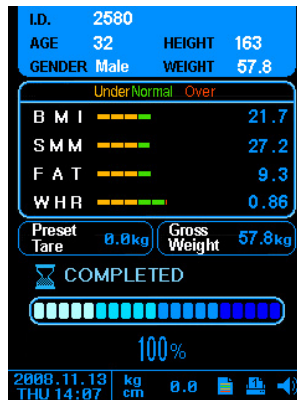

Through the display of the results, you can check the main items of the results sheet that the InBody230 prints out.

B. Result Sheet

With a printer connected to InBody230, result sheets can be printed out.

(1) Printer Connection

- 1 USB Printer
USB printer works.
Use the printers recommended by InBody.
Refer to chapter5.Consumables and the user's manual provided by the printer manufacturer for installation of a printer.

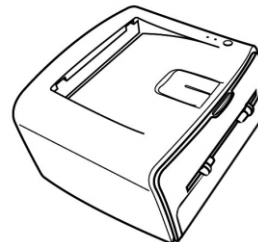

2 Thermal Printer

The roll paper is consumable. Use the roll paper which InBody provides.
Please contact InBody or an authorized distributor to place the purchase order.

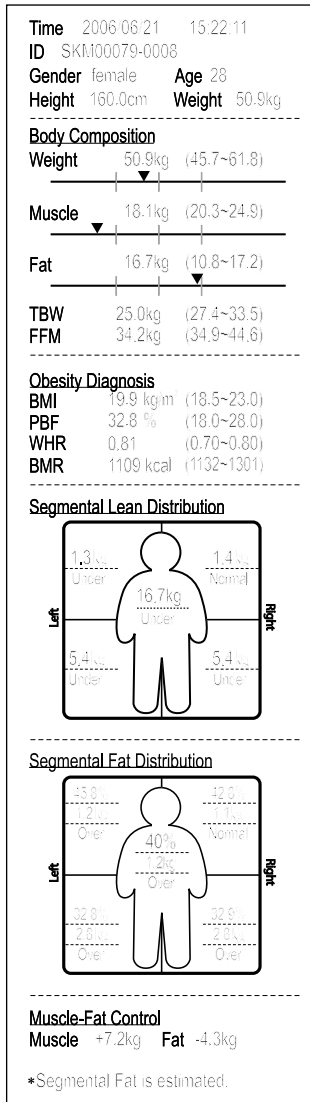

C. Output Items (Result sheet for all ages)

The following are the explanations for each item. About 23 items are analyzed on the result sheet.

(1) Personal Information

The examinee's name / ID, age, height, gender, date & time are displayed here.

ID	SKM00079-0008	Height	160cm	Date	2006.6.21
Age	28	Gender	Female	Time	15:22:11

InBody

(2) Body Composition

The measured values of the examinee's body composition are displayed here.

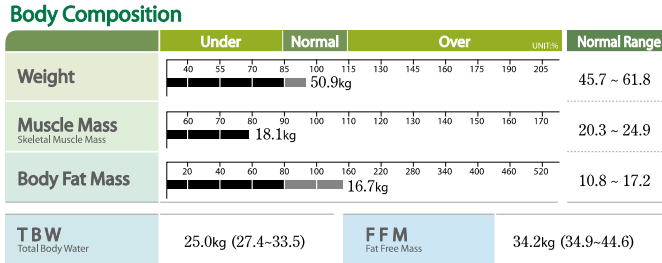

1 Body Weight (kg)

Standard weight indicates the ideal value proportionate to the examinee's height. The InBody230 provides the standard weight range, based on the BMI (Body Mass Index) Standard Weight Index.

2 Skeletal Muscle Mass (kg)

Distinctively, skeletal muscle mass, which generally indicates the lean body mass of each arm and leg, can be controlled by exercise and dietary habits. Compare the bar graphs lengths of skeletal muscle mass with body fat mass. If the bar of skeletal muscle mass is relatively shorter and under the standard value, lean body mass lacks in the body, while the opposite case is proper. 100% signifies ideal lean body mass when examinee's weight is normal. The standard range is 90~110% of standard skeletal muscle mass based on standard weight.

3 Body Fat Mass (kg)

The standard range of Body Fat Mass is ascertained by calculating an examinee's Body Fat Mass as compared to the standard weight and standard Body Fat Mass. The InBody230 displays the percentage of the standard value of Body Fat Mass scored by the examinee in a bar graph.

4 Total Body Water (kg)

The total water in the body.

5 Fat Free Mass (kg)

(3) Obesity Diagnosis

This enables you to analyze the obesity degree in a convenient and accurate fashion. The numerical value at the end of the bar graph shows you the examinee's body fat in relationship to the standard body fat range.

Obesity Diagnosis

	Value	Normal Range	
BMI Body Mass Index (kg/m ²)	20.5	18.5 ~ 25.0	$\text{BMI} = \frac{\text{Weight, kg}}{(\text{Height, m})^2}$
PBF Percent Body Fat (%)	28.5	18.0 ~ 28.0	$\text{PBF} = \frac{\text{Fat, kg}}{\text{Weight, kg}} \times 100$
WHR Waist+Hip Ratio	0.79	0.75 ~ 0.85	
BMR Basal Metabolic Ratio (kcal)	1450	1320 ~ 1580	$\text{WHR} = \frac{\text{Waist circumference, cm}}{\text{Hip circumference, cm}}$

1 BMI (Body Mass Index, kg/m²)

Body Mass Index is a convenient way of assessing the degree of obesity. Body composition and Lean Body Mass are not considered. BMI is determined using only the weight and height. The InBody230 identifies a standard BMI of 22 for males and 21.5 for females.

Formula) BMI = weight (kg) ÷ height² (m²)

Determination 1) WHO Standard

BMI(kg/m ²)	Classification		Diagnosis
<18.5	Underweight	Under	Infectious disease, malnutrition related disease
18.5~24.9	Normal	Standard	Least risk at most disease
25.0~29.9	Overweight	Over	May cause health problem
30.0~34.9	Obese1		Increase of the risk of cardiac disease,
35.0~39.9	Obese2		high blood pressure, diabetes, etc
>40	Severely Obese		

Ref. WHO and the National Heart, Lung, and Blood Institute : clinical guidelines on the identification, evaluation, and treatment of over weight and obesity in adults, the evidence report. June 1998, xiv

Determination 2) Asian-Pacific Standard

BMI(kg/m ²)	Classification	Risk of associated disease
<18.5	Underweight	Low (high risk of other clinical disease)
18.5~22.9	Normal	Average
>23	Overweight	
23~24.9	Risky Overweight	Increased
25.0~29.9	Obese step1	Moderate
>30	Obese step2	Severe

Ref. Korean Society for the Study of Obesity, chapter 2. Redefining and Evaluation, The Asian-Pacific perspective: Redefining Obesity and its Treatment., 1st edition, Korean Society for the Study of Obesity, 2001, p10.

For children under the age of 18, children's standard is used.

2 Percent Body Fat (%)

Percent Body Fat indicates the percentage of body fat to body weight. The standard percent body fat is 15% for men and 23% for women, while the standard range of body fat for men is 10-20% of the standard weight and 18%-28% of the standard weight for women. In case of children under the age of 18, a different standard is used.

Ref. Samuel J. Fomon, M.D., et al. Body Composition of reference children from birth to age 10 years. The American Journal of Clinical Nutrition, 35, 1169-1175, 1982.

3 Waist-Hip Ratio

Waist-Hip Ratio (WHR) means ratio of waist and hip circumference.

InBody230 yields WHR value saving the effort of tape measurement, using the principle which figures out body size with segmental bioimpedance and reference of empirical factors. The WHR value measured from InBody230 is found to be $r=0.901$ and $SEE=0.032$ comparing with the value measured by anthropometry. The standard ranges are 0.80~0.90 for male and 0.75~0.85 for female. Abdominal obesity is diagnosed in case of over 0.90 for male and 0.85 for female. For Asian, the normal range of WHR is 0.75 ~ 0.85 for male and 0.70 ~0.80 for female.

Measuring Waist-Hip Ratio

Waist circumference : at the umbilical point

Hip circumference : at the widest point of hip

*Ref.1. Judith E. Brown, Nutrition Now, 2nd edition, pp9-8, published by West/Wadsworth, 1999.
2. NIH, Bioelectrical impedance analysis in body composition measurement : National Institute of Health, 1996. Technology Assessment Conference Statement, 524S-532S, December 12-14, 1994.*

4 Basal Metabolic Rate (Kcal)

The Basal Metabolic Rate (BMR) indicates the minimum energy requirements needed to sustain vital functions while at rest. The InBody230 makes it possible to estimate BMR using a known regression equation based on LBM (Lean Body Mass). LBM is known to be closely related to BMR.

(4) Segmental Lean

'Segmental Lean' shows that the level of segmental muscle mass in consideration of an examinee's weight. Description of picture is followed as below.

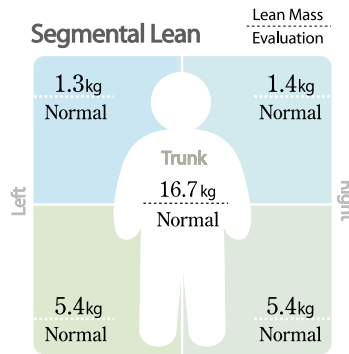

(5) Segmental Fat

'Segmental Fat' shows segmental fat mass, percent body fat and its overall evaluation. Description of picture is followed as below.

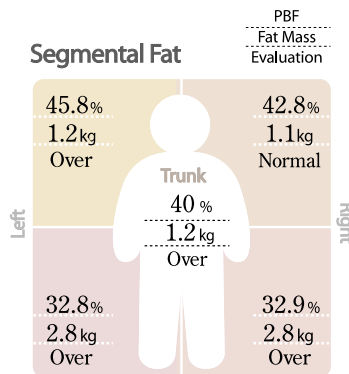

* Segmental Fat is estimated.

(6) Muscle-Fat Control**Muscle-Fat Control**

Muscle Control	+ 7.2 kg	Fat Control	- 4.3kg
-----------------------	----------	--------------------	---------

1 Muscle Control (kg)

The amount of muscle to be controlled. The (+) and (-) signs are an increase or decrease in the amount of control.

2 Fat Control (kg)

The amount of fat to be controlled. The (+) and (-) signs are an increase or decrease in the amount of control.

(7) Impedance (kHz)

It shows the impedance values from the measurements at 2 frequencies (20, 100kHz). For further research purposes, from the left to the right, it shows the values for the right arm, left arm, trunk, right leg and left leg. This data indicates if the measurement is wrong or the unit is defective.

Impedance

Z	RA	LA	TR	RL	LL
20kHz	476.8	514.6	31.7	324.0	324.7
100kHz	439.3	477.0	28.3	296.2	297.0

(8) Exercise Planner

























The InBody230 can not only make a recommendation on the type of exercises you should do but also can assess the weight loss effect of the recommended exercises.

Select exercises to carry out with reference to the list of exercises on the results. Based on the rate of calorie consumption for the exercise, gauge your calorie consumption per week. After calculating the sum of calorie consumption, calculate the expected weight loss for a month. If the sum of calorie consumption calculated is for one week, multiply the estimated calories by 4 to derive the monthly calorie consumption.

The total calorie to be consumed to lose 1kg of fat is 7700 kcal. Thus if you divide the calculated calorie consumption for four weeks by 7700, you can get the possible loss of fat during a month. As the examinee can calculate his or her own weight loss based on the exercise prescription, it heightens his or her motivation to put the plan in practice with tangible goals.

Exercise Planner

Plan your weekly exercises from the followings and estimate your weight loss from those activities.

Energy expenditure of each activity (base weight: 51.6kg / Duration: 30min. / unit: kcal)						
 Walking 102	 Jogging 178	 Bicycle 153	 Swim 178	 Mountain Climbing 166	 Aerobic 178	
 Table tennis 115	 Tennis 153	 Football 178	 Oriental Fencing 255	 Gate ball 97	 Badminton 115	
 Racket ball 255	 Taekwon-do 255	 Squash 255	 Basketball 153	 Rope jumping 178	 Golf 90	
 Push-ups development of upper body	 Sit-ups abdominal muscle training	 Weight training backbone prevention	 Dumbbell exercise muscle strength	 Elastic band muscle strength	 Squats maintenance of lower body muscle	

• How to do

1. Choose practicable and preferable activities from the left.
2. Energy expenditure for each is calculated when it is done for 30 min.
3. Choose exercises that you are going to do for 7 days.
4. Calculate the total energy expenditure for a week.
5. Estimate expected total weight loss for a month using the formula shown below.

Calculation for expected total weight loss for a month (one month = 4 weeks)

$$\text{Total energy expenditure (kcal/week)} \times 4 \text{ weeks} \div 7700$$

• Recommended calorie intake per day

1400 kcal

D. Output Items (Result Sheet for Child)

The following are the definitions and explanation for each item analyzed on the result sheet.

- 1) Enter I.D., age, and gender using the keypad of the device.
- 2) User logo can be entered by the provider through external software only.
Enter user name, address and the name of doctor in charge and other details.

I.D.	Age	Height	Weight	Gender	Date /Time
HKE-0008	10	148cm	45.2kg	Girl	2008.03.05/09:56

InBody
TEL:02-501-3939, FAX:02-501-3978

- (3) Let's discover what my body is made up of?

This part provides qualitative values of the body composition. Alongside the measured values of each body composition, there is nutrition evaluation from the measured values to help children understand. It would be good to explain what roles proteins, minerals, fattiness play in our body and what problems might occur when these are lacking or too abundant. The body composition analysis of InBody is based on the 4-compartment model.

Let's discover what my body is made up of ?

Occupying most of my body	Body Water	22.1 kg	Too little
Making muscle	Protein	6.0 kg	Too little
Making bones strong	Mineral	2.22 kg	Enough
Storing extra energy	Body Fat	14.9 kg	Too much

1 Body Water (kg)

It covers the largest portion among body composition accounting for about 50~70% of body weight. It is distributed in the cells and body fluids. If we look into our body from composition point of view, it is like a systemized sea water bag. Body water is mostly distributed at the cells which compose the muscle tissue and over 70% of water fills healthy person's muscle while minerals and body fat do very little.

2 Protein (kg)

Protein is a complex of organic compounds with nitrogen and it indicates the total amount of solid components. Protein has very close relationship with intracellular fluid and the lack of protein means the nutritional imbalance. However this does not mean the protein in food. If there is a severe shortage in protein mass, it can bring symptoms such as loss of nails and toenails, amenorrhea, hair discoloring, muscle atrophy, fatty liver, edema, etc.. Human body consumes body composing proteins when there is shortage in energy provision in body. This is an undesirable energy generation process and if excessive rates of such process continue for a long time of period, it could burden liver, kidney and others. For growing children, protein is an essential component in particular. During a growth period various parts of our body are developed especially skeletal structure and muscle mass. Therefore, it is necessary to have sufficient amount of protein during a growth period since major components of muscle is the protein.

3 Mineral (kg)

During a growth period when there is a dramatic growth in bones, it is necessary to have good mineral to ensure the smooth development of a skeleton structure.

4 Body Fat (kg)

Fat free mass is the sum of body water, protein and mineral. Thus, InBody uses the following formula to get the amount of body fat.

$$\begin{aligned}\text{Body Fat} &= \text{Weight} - \text{FFM} \\ &= \text{Weight} - (\text{body water} + \text{protein} + \text{mineral})\end{aligned}$$

The sum of body water, protein, mineral, and body fat, which explained so far constitutes the weight.

(4) Shall we check if my body is well balanced?

This part shows the measured values of weight, skeletal muscle mass, and body fat mass, and their relative comparison in figures and in graphs. The figures next to the bar graphs indicate the measured values of each composition.

The graphs consist of 10 steps, from 1 to 10, and the 4th and 5th step is the normal range. Where the face mark is stamped is where the examinee belongs to. You'll get the smile face stamp if the status of each composition is good, or you'll get the long face stamp if it is bad.

Shall we check if my body is well balanced ?

			Under			Normal	Over					
My total	Weight	45.2 kg	1	2	3	4	5	6	7	8	9	10
For a great body shape	Muscle	16.0 kg	1	2	3	4	5	6	7	8	9	10
Am I storing too much	Body Fat	14.9 kg	1	2	3	4	5	6	7	8	9	10

1 Weight (kg)

100% ideal weight indicates the ideal value for the examinee's height. Ideal weight is obtained from BMI ideal weight calculation.

BMI ideal weight calculation

Ideal weight (kg) = ideal BMI (kg/m²) × the square of the height in meters (m²)

Ideal BMI follows young children's BMI by height and gender.

2 Skeletal Muscle Mass (kg)

Muscle in this part refers to the skeletal muscles attached to the bones. 100% ideal muscle indicates the ideal amount of muscle that one should have when the examinee has an ideal weight.



In particular, as bone development actively progresses during a growth period, it is necessary to have a well-developed skeletal muscle mass to supports smooth growth of bones.

3 Body Fat (kg)

It covers the largest portion among body composition accounting for about 50~70% of body weight. It is distributed in the cells and body fluids. If we look into our body from composition point of view, it is like a systemized sea water bag. Body water is mostly distributed at the cells which compose the muscle tissue and over 70% of water fills healthy person's muscle while minerals and body fat do very little.

(5) Is my body growing well?

With the DSM-BIA(Direct Segmental Multi-frequency Bioelectrical Impedance Analysis) measurement method, the InBody measures lean mass of each body parts. Therefore, based on the segmental lean mass, it is possible to find out whether the examinee's body parts are strong or not and well balanced or not.

There are 14 cases in the squares, the development status of arms is where the  is stamped and the development status of legs is where the  is stamped.

Is my body growing well ?

 Look at the comment of palm marking. It shows the muscle state of arms.	You are rather chubby.	It will be great if you grow more.
 Look at the comment of foot marking. It shows the muscle state of legs.	Good!	You look weak.
You are rather developed.	Good enough.	You are lack of muscle.
You are developed though you are slim.	Very good!	You look too weak.
Your muscles are like an athlete players.	Your muscle is weak for the weight.	Your muscle is ok for the weight but you look weak.

Am I well balanced?

The Body Balance function verifies that the muscles in each part of the body are developed in a balanced manner, examining differences between the muscles in both arms to evaluate the upper body balance, in both legs to evaluate the lower body balance, and in both arms and legs to evaluate the upper-lower body balance.

Am I well balanced?

Arms	Balanced	Slightly Unbalanced	Extremely Unbalanced	- Balance between right arm and left arm
Legs	Balanced	Slightly Unbalanced	Extremely Unbalanced	- Balance between right leg and left leg
Arms & Legs	Balanced	Slightly Unbalanced	Extremely Unbalanced	- Balance between upper and lower body

(6) Where am I in height and weight among my 100 friends?

This part is to check a examinee's developmental status through a percentile graph that enlarges a growth curve according to his/her age and gender.

Percentile is a score that shows one's relative position in the distribution of the group to which he/she belongs. The 50th percentile (50%) indicates a mean value, and if it is closer to the 50th percentile, it means one's growth is at a rate close to the middle. However, there is no need for worry if one falls between the 10th percentile (10%) and the 90th percentile (90%), rather than the 50th percentile. But if one is lower than the 10th percentile (10%) or higher than the 90th percentile (90%), special care is necessary.

Where am I in height and weight among my 100 friends? The taller and the heavier, numbers will increase.

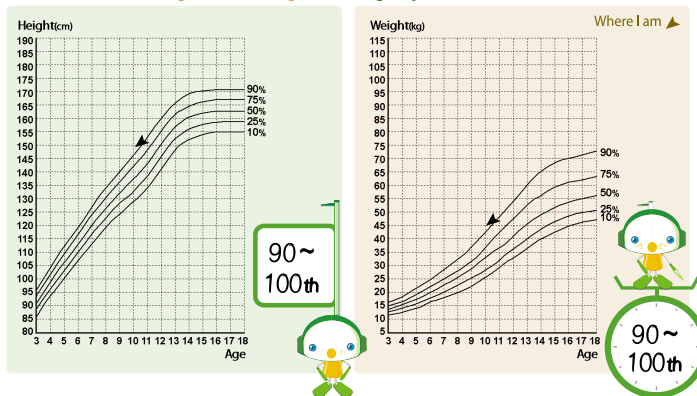

(7) What is my ideal weight?

For growing children, it is not a good idea to blindly lose weight to achieve an ideal weight. It would be advisable to maintain ideal body components while monitoring muscle mass and the amount of body fat.

What is my ideal weight ?

For my ideal muscle mass	Need to gain	3.6 kg
For my ideal body fat mass	Need to lose	6.3 kg
For my ideal weight	Need to lose	2.7 kg

So, what is my ideal weight?

42.5 kg

(8) Evaluation of my body

Evaluation of my body

BMI Body Mass Index	20.6 kg/m ²	normal	under	over	extremely over
PBF Percentage Body Fat	33.0 %	normal	under	slightly over	extremely over
OD Obesity Degree	107 %	normal	weak	over weight	extremely over
BMR Basal Metabolic Rate	1025 kcal	normal	under	over	

What is my growth score?

87 Points

1 BMI

The ideal BMI for children below 18 years old differ from each other by height and gender. The standard BMI range is within ± 3 of ideal BMI.

BMI < Ideal BMI - 3	under
Ideal BMI + 3 \leq BMI < Ideal BMI + 6	over
Ideal BMI + 6 \leq BMI	extremely over

2 Percentage Body Fat

Children below 18 years of age have different ideal percentage body fat depending on their gender and height. The standard range is within $\pm 5\%$ of ideal percentage body fat. 'Slightly over' refers to a stage with a risk of obesity and is when one has larger than or same as +5% of an ideal percentage body fat and smaller than +10% of an ideal percentage body fat. 'Extremely over' is when percentage body fat is larger than or equal to +10% of an ideal percentage body fat.

3 Obesity Degree(%)

Obesity Degree(%)= (current weight/ standard weight by height) × 100

Obesity Degree is an index that determines obesity without considering individual body composition. The standard range stretches from above 90% and below 110%. Above 110% and below 130% is 'over weight' and above 130% indicates 'extremely over.'

4 Basal Metabolic Rate (BMR)

Basal Metabolic Rate (BMR) is a value obtained by substituting the fat free mass of current examinee to a formula. The standard range stretches from above 90% and below 110%. Less than 90% indicates below standard and more than 110% is regarded as above the standard BMR. Ideal BMR is a value obtained by substituting the ideal fat free mass of a examinee to a formula.

(9) What is my growth score?

Growth score is a unique score of InBody that shows test results in recognizable scores so as to help understand the growth stage of children by taking into account physique and body components. It considers not only children's body composition but also obesity index degree, and physique such as height and weight.

What is my growth score?

87 Points



Chapter 3 Setup Establishment

1. How to Modify Settings
2. Setup Menu
3. Quick Setup

1. How to Modify Settings

The setup allows you to customize several functions through modification. The below setup screen appears as pressing the SETUP button on the keypad at the initial screen. The setup of the InBody230 consists of 5 items; Region, Printer, Result, Others and Interface.

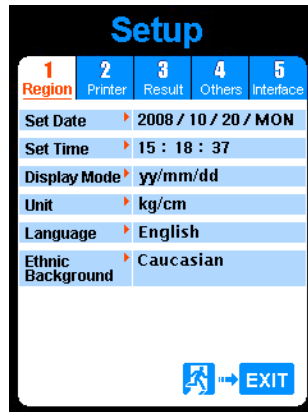

- (1) Use the left and right buttons (◀, ▶) or number buttons to select a category among Region, Printer, Result, Others and Interface. Then selected item's subcategories are displayed on the screen.
- (2) Use the upper and lower buttons (▲, ▼) to move to the subcategories.
- (3) Use the right button (▶) to select the category and press the ENTER button to move into the options. Press the upper and lower buttons (▲, ▼) to modify the option you select.
- (4) Use the left button (◀) or the EXIT button to move out from that category.
- (5) Use the upper button (▲) or number buttons to go into other categories: Region, Printer, Result, Others or Interface
- (6) Use the EXIT button to finish the setup menu.
- (7) It will be automatically saved as you move out from the setup menu.

2. Setup Menu

A. Region

Set the date, time, display mode, unit, ethnic background and language.

(1) Set Date

Set the date using upper, lower buttons(▲, ▼). Use left, right buttons(◀, ▶) or ENTER button to move to year, month and date.

(2) Set Time

Set the current time using upper, lower buttons(▲, ▼). Use left, right buttons to move to hour, min, and sec.

(3) Display Mode

Select the date display mode. (yy/mm/dd, mm/dd/yy, dd/mm/yy)

(4) Unit

Select units to be used for weight and height. (kg/cm, kg/in., lb./cm, lb./in.)

(5) Language

Select the language to be used.(English, Spanish_BK, Spanish, German, Italian, Portugal, Chinese, French, Czech, Turkish)

(6) Ethnic Background

Select the ethnic background of the examinee(Asian, Caucasian, African, Hispanic, Others).

B. Printer

(1) Printer

Printers that support PCL and SPL are compatible with InBody230.

(2) Alignment

It is possible to adjust the coordinates on the result sheet. Use upper, lower buttons to adjust it for the desired location. Use left, right buttons to move between X and Y axis. The new adjustment can be previewed by 'Test Print'.

(The adjustment range: X(left, right), Y(upper, lower) +50~-50)

(3) Test Print

You can check the printing coordinates by printing out a sample. Press 'PRINT' .

(4) Thermal Printer

- ① Enable : If the thermal printer is selected from E.Interface, it would be indicated as "Enable". For a test print, move the cursor to 'Enable' and press 'Print' button.
- ② Disable : It appears when the thermal printer is not in use.

C. Result

(1) Mode

- ① Printed : To use printed result sheet provided by InBody.
- ② Built-in : To use plain A4 paper. All formats of the result sheet will be printed out.

(2) Number of Result Sheet Printing

You can decide the numbers of result sheet to be printed. (0,1 or 2)

(3) BMI Standard

Select the standard range of BMI.

- ① Asian : The standard range is 18.5~23.0kg/m²
Asian standard is shown at the set up if 'Asian' is selected as the ethnic background only.
- ② WHO : The standard range is 18.5~25.0kg/m²

(4) Logo Type

Select a logo to be printed on the result sheet.

- ① BMP Image : To be selected when a computer is used to upload a logo. In this case, it cannot be uploaded by an user and must be contacted with a local distributor of InBody.
- ② User Input : To be selected when a keypad is used to directly upload a logo. When you press ENTER button, a screen for logo upload will appear. Logo must be created with alphabets and numbers.

(5) I.D.

- ① User Input : User enters the I.D.
- ② Default(GUEST) : Use the I.D., 'GUEST' which is provided by InBody230.

(6) Weight Control

This is an option of weight control provision on the results sheet.

- ① Blank : No printout provision of weight control.
- ② Printed : Printout provision of weight control.

(7) Pediatric Mode

- ① Enable : Select when you want to print the result sheet for child. The age to distinguish between adult and children can be set up by choosing the number next to 'Enable'. For instance, if you set up the age 18, anyone less than 18 years old will have a report for child.
- ② Disable : Select when you want to use the InBody230 result sheet for all ages.

(8) Exercise Planner

This is an option of exercise planner provision on the results sheet.

- ① Blank : No printout provision of exercise planner.
- ② Printed : Printout provision of exercise planner.

D. Others

(1) Measure Weight

- ① Auto : Starts the weight measurement when an examinee stands on the foot frame.
- ② User Input : To be selected when an examinee directly enters weight value in the personal information window.

(2) Adjust Weight

Used to adjust weight offset value. When you want to adjust the weight due to the heavy clothes or accessories, set the offset value.

It will be reflected for the weight measurement.

(Calibration Range : +5.0kg ~ -5.0kg, step: 0.1kg or +10.0lb. ~ -10.0lbs., step : 0.1lbs.)

(3) Volume

Used to control announcement or sound volume (0~8).

(4) Sound

- ① Beep : Use Beep sound to inform measurement status.
- ② Off : Keep silent during the measurement.

(5) Delete History

Used to erase the entire history data.

All data will be deleted when you press Enter button.

(6) Version

Shows the current program version.

E. Interface

Sets the connection of external device to InBody230.

(1) Lookin' Body

Select to use Lookin' Body (Enable, Disable)

(2) COM1(Serial)

Select the external device to be connected with 9 pin serial port.

- ❶ Disable : Do not use 9 pin serial port.
- ❷ SD400 : Select when you use SD400. The maximum of 4 devices from below can be used with port1~port4
- ❸ Lookin' Body : Select when you use Lookin' Body with 9 pin serial cable.
- ❹ Thermal : Select when you use a Thermal Printer.

F. Example for Environmental Setup

(1) To use general A4 plain paper

- ❶ Press SETUP button.
- ❷ Use right button or 2 from keypad to move into the Result category.
Press lower button to move into the sub-category and right button to enter 'Mode'.
- ❸ Select 'Built-in' with upper, lower buttons and press EXIT button.

(2) To input the logo directly from the unit

- ❶ Press SETUP button.
- ❷ Use right button or 3 from keypad to move into the Result category.
Press lower button to select 'Logo Type'.
- ❸ Use right button to move into 'Text' category.
- ❹ Press ENTER button and activate the input window.
- ❺ Create the logo with alphabets and number. Press ENTER button to save.

3. Quick Setup

A. How to modify the quick setup

When you press 'MODE' button, the quick setup screen will appear as below. Use left, right buttons(◀▶) to move into the category that needs the quick setup and use lower, upper buttons(▲▼) to move into the sub-category that wished to be changed. Press ENTER button to save the change and press EXIT button to go back to the previous screen.

B. Items

(1) Unit



Select the unit to be used for weight and height(kg/cm, kg/in., lb./cm, lb./in.).

(2) Weight Adjustment

Adjust the weight offset value. When the additional weight due to the clothes or accessories needs to be taken off, set the desired offset value. It will be reflected for the weight measurement.

(The weight adjustment range : +5.0kg ~ -5.0kg, Adjustment unit : 0.1kg or +10.0lb. ~ -10.0lbs., adjustment unit : 0.1lbs.)

(3) Result sheet selection

- ① Printed  : The result is printed on the custom result sheet provided by InBody.
- ② Built-in  : The result is printed on the A4 paper.

(4) Number of result sheet

Select the number of result sheet to be printed after the measurement. (0,1,2)

(5) Volume

Adjust the volume of the sound. (0~8)



Chapter 4 Problems & Solutions

1. Error Messages
2. Troubleshooting
3. Frequently Asked Question (FAQs)
4. Customer Service Information

1. Error Messages

The InBody230 display an error message to alert the operator of problems and to recommend the correct action.

A. "Remove any objects on the footboard"

When pressure or weight is applied to the base frame during self-calibration, this message appears. Turn the InBody230 off and on again after removing the material from the base frame. Please do not apply pressure or weight to the base frame during self-calibration.

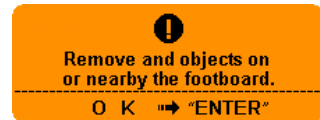

B. "Enter the personal data again"

If entered examinee data are beyond acceptable ranges, this error message appears. When inputting examinee data, do not exceed the acceptable ranges of age and height, please refer to Chapter2, section 5:"Personal Profile."



C. "Try again after wiping hands and feet"

If this message still display on the LCD after checking the examinee's posture on the second trial, a examinee's sole and palm are too dry to be measured precisely. In this case, a examinee should wipe his/her sole and palm with wet tissue and try again.

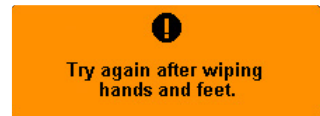

2. Troubleshooting

This section lays out the order of steps you have to take in case of malfunction, with the assumption that you have some basic knowledge about how to operate the equipment. If you still have the problem after taking the following steps, contact InBody.

A. The equipment does not seem to run, even after the power is on.

(In a normal situation, a signal sounds and the LCD is turned on.)

Cause 1 The plug is not pushed all the way through the electrical outlet.

Action 1 Push the plug all the way into the electrical outlet.

Cause 2 Extension is not turned on (when using a surge protector) or the power does not flow into extension.

Action 2 Check if the power flows into the extension and the electrical outlet where the extension is connected.

Cause 3 When an adapter not provided by InBody is used.

Action 3 Only use the adapter provided by InBody.

Cause 4 Adapter is not tightly inserted into the InBody230.

Action 4 Insert the adapter into the power input port tightly.

B. The LCD is turned on, but there is no picture on the LCD.

(In a normal situation, the beep sounds and the InBody230 logo is displayed on the LCD.)

Cause 1 If the contrast control is not set properly, the LCD will not display icons/images clearly.

Action 1 Adjust the contrast control at the rear of the InBody230 by rotating it to the right or to the left until the picture becomes clear.

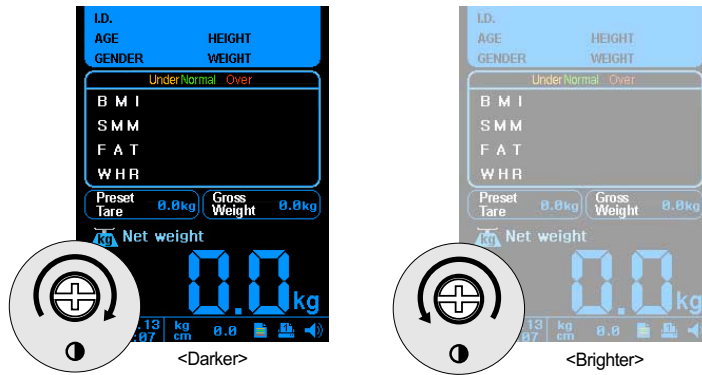

C. The measured weight value seems very low, or shows a negative value.

(Normally the measured weight is not very different from what the examinee believes his or her actual weight to be).

Cause 1 The weight sensor (loadcell) calibration was performed wrong during the self-calibration.

Action 1 Turn off the power of the InBody230, then turn it on again. Allow the unit to perform the self-calibration process again with no weight on the base frame. The loadcell will be set to 0 kg. During self-calibration, therefore, even a small amount of weight will negatively affect the calibration.

D. The analysis results are unexpected or unusual.

(It is not common to observe unexpected values. All analyzed values should not be outside of pre-determined ranges).

Cause 1 A examinee failed to maintain proper posture. He/She removed fingers or the sole of the foot from the tactile point of the electrodes.

Action 1 He/She must maintain proper posture until the analysis is complete. Refer to Chapter 2, section 6: “Proper Posture” for more information. If the repeated analysis results are the same, contact InBody.

E. The results sheet is not printed from printer.

(In normal situation, the results sheet is automatically printed out after the measurement).

Cause 1 Occur when the paper tray is empty.

Action 1 Check if there is an indicator light or message on the printer. If the tray is empty then refill it with results paper. Be sure to place the paper properly in the tray (proper direction and surface orientation).

Cause 2 Occurs when the printer cable is unplugged.

Action 2 Ensure the cable is connected tightly to InBody230. Occasionally this may occur as a result of a bad cable. In this case, you must replace the cable.

Cause 3 Occurs when the paper is jammed inside the printer.

Action 3 Check if the paper is jammed inside. Normally, you will be alerted by the indicator light or message. Remove the paper jam and try again. Refer to the manual provided by the printer manufacturer.

Cause 4 Occur when the printer or the InBody230 setup is incorrect.

Action 4 If it is the wrong type of printer, the printer will not receive a signal from the InBody230. Refer to Chapter 3. "Setup Establishment."

F. Printing alignment needs to be adjusted

(Normally, printing alignment correlates with each result item shown on the results sheet).

Cause 1 Occurs when graphs are not aligned with the result sheet paper.

Action 1 Use the arrow icons in Printer Alignment section of the Result Sheet Setup menu to adjust the alignment. The distance moved is shown based on an X-Y axis coordinate system. The graphs are moved slightly each time the arrow icon is selected. Refer to Chapter 3, section 2: "Setup Menu."



CAUTION

When connecting a printer to the InBody230, turn on the power of the printer before turning on the InBody230. When turning the power off, turn off the InBody230 before turning off the printer. This process will minimize the harm to the equipment caused by electric shock.



NOTE

Occasionally the printing direction can be problematic. Refer to the printer manual provided by the manufacturer.



NOTE

Error messages and misprints are things that technical service representatives can examine in the process of troubleshooting, keep them in a safe or keep record of them.

3. Frequently Asked Question (FAQs)

Even if no problems arise from the equipment, users may still have many questions especially regarding clinical procedures. Below, just a few of the more common questions are listed with answers. If additional questions or more clarification is desired, please contact us by E-mail. The E-mail address for clinical questions is as follows:

E-mail: info@inbody.com

A. Must socks or stockings be removed from the feet for analysis?

Bare skin contact is essential in the analysis using the BIA method. Socks or stockings may cause a certain amount of distortion in the results. Socks and stocking must be removed to obtain accurate data.

B. What are the circumstances where an analysis cannot be performed?

Subjects who have a pacemaker or other internal electronic medical devices should never use the InBody230.

An accurate analysis cannot be obtained for children weighing less than 10kg. (22lbs) or people over 250kg (551lbs), or whom is shorter than 85cm (2ft. 9.5in.) or taller than 220cm (7ft. 2.6in.) in height.

If the examinee has a metal device embedded in the body, then the electrical current flow rate may be affected. Since the InBody230 calculates body composition based on flow rate from each part of the body, the error will be slight.

C. Can amputees or people who cannot stretch their hands or feet to the electrode be tested?

It is impossible to measure people who cannot contact the electrodes.

D. Is the electrical current applied to a human body through electrodes safe?

The BIA method uses 330 μ A of current which is negligible and will cause no harm to the humanbody.

The InBody230 has acquired the CE and other certifies that assure the safety of the medical equipment.

E. Do accessories (jewelry, watches, rings, etc.) or any other metal objects worn by an examinee affect the analysis?

The ideal condition for the analysis is simply standing with no clothes (naked) and wearing no accessories. However, this may not always be possible. Therefore, we recommend an examinee remove as many clothing items and accessories that may affect the weight as possible. There will not be any problems as long as the accessories do not interfere with proper electrode contact.

F. How often does the examinee perform the analysis?

When the examinee is under treatment related to body composition, such as an exercise prescription, hormone prescription, or treatment for obesity and rehabilitation, the analysis should be performed once every two to four weeks.

G. What does the examinee follow for accurate analysis?

For accurate analysis, InBody recommends the following:

- measure with an empty stomach
- measure 2 hours after a meal
- measure after urination and excretion
- to get net weight, remove heavy clothes or accessory
- do not exercise or take a shower before measurement
- measure after standing for at least 5 minutes
- do not measure after abruptly standing
- do not measure while taking a diuretic
- for female, avoid having measurement during menstrual period
- input accurate height
- keep room temperature at 20 ~ 25°C (68 ~ 77°F)
- warm up yourself for 20 minutes before a test in winter

H. How reliable is WHR value?

The WHR value obtained from InBody230 has the correlation rate of 0.901 in comparison with the real value. This correlation rate is little lower than those of other values, but the WHR value saves the user from measuring the circumferences of each body part with tape measures. Most of all, it guarantees high reproducibility of measurement. WHR is one of the values that only InBody provides among impedance equipments.

4. Customer Service Information

Corporate agents of the InBody230 and addresses are listed below. Contact us for assistance or more information about the InBody230.

InBody Co., Ltd. [HEAD OFFICE]

InBody Bldg., 54, Nonhyeon-ro 2-gil, Gangnam-gu, Seoul 135-960 KOREA

TEL: +82-2-501-3939 FAX: +82-2-578-2716

Website: <http://www.inbody.com>

E-mail: info@inbody.com

InBody [USA]

13850 Cerritos Corporate Dr., Unit C, Cerritos, CA 90703, USA

TEL: +1-323-932-6503 FAX: +1-323-952-5009

Website: <http://www.inbodyusa.com>

E-mail: info@inbodyusa.com

InBody Japan Inc. [JAPAN]

Tani Bldg., 1-28-6, Kameido, Koto-ku, Tokyo 136-0071 JAPAN

TEL: +81-3-5875-5780 FAX: +81-3-5875-5781

Website: <http://www.inbody.co.jp>

E-mail: inbody@inbody.co.jp

EU Representative. [EUROPE]

DongBang Acuprime. 1 Forrest Units, Hennock Road East, Marsh Barton, Exeter EX2 8RU, U.K

TEL: +44-1392-829500 FAX: +44-1392-823232

Website: <http://www.inbody.com>

E-mail: info@acuprime.com

Biospace China. [CHINA]

904, Xing Di Plaza, No. 1698 Yishan Road, Shanghai, 201103, CHINA

TEL: +86-21-64439738, 9739, 9705 FAX: +86-21-64439706

Website: <http://www.biospacechina.com>

E-mail: info@biospacechina.com

Australian Sponsor. [AUSTRALIA]

Emergo AUSTRALIA. Level 20, Tower II, Darling Park, 201 Sussex Street, Sydney, NSW 2000, AUSTRALIA

TEL: +61-2-9006-1662 FAX: +61-2-9006-1010

Website: <http://www.emergogroup.com>

E-mail: Sponsor@emergogroup.com



Chapter5 Consumables

1. Consumables
2. Options

1. Consumables

A. Result Sheet

When using the InBody230 with a printer, it is strongly recommended to use the result sheet supplied by InBody. If more result sheets are needed, please contact InBody.

Result sheet Size : 210mm × 297mm(A4 type)

Number of Sheets : 500 / 1box

Printed Condition : 4 colors

Manufacturer : InBody Co., Ltd

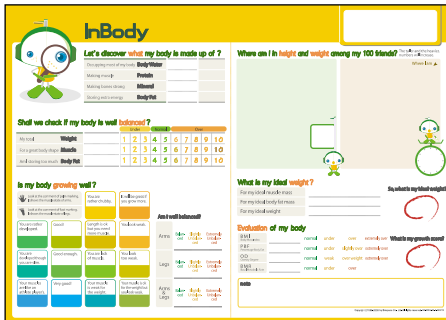

<Result sheet for child>

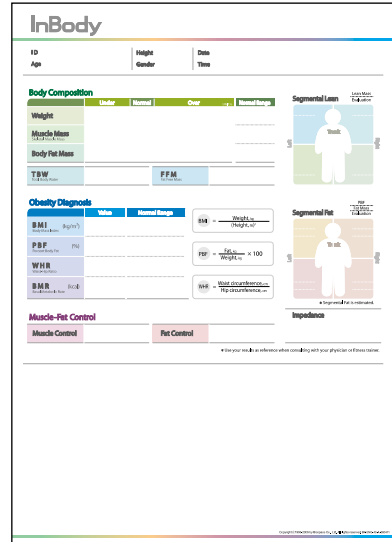

<Result sheet for all ages>

B. Roll Paper

When you use the thermal printer for printing, the right size of roll paper is required as below.

External diameter : 45mm Width : 57mm

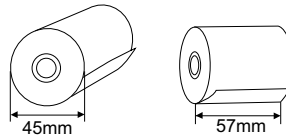

2. Options

InBody provides optional devices to make the operation of InBody230 more efficient and convenient. For more information, contact the head office or authorized distributors of InBody.

A. Printer

Printers using PCL3 or above would be compatible. If you have a printer using PCL3 or above but is not listed on the compatible printer list provided by InBody, please contact us to check compatibility. Most of the printers do not include a USB cable, please purchase it separately.



NOTE

Only use the printers recommended by InBody.

B. Printer Desk

The printer desk supplied by InBody has a drawer, which can be used for keeping result sheets. Also, printer desk minimizes vibration during printing. The exterior and specifications of the printer desk are: Materials : E.G.I

Size : 480(W) × 400(L) × 710(H), unit : mm

Weight : 13kg



NOTE

To assemble the printer desk, refer to assembling guide printed on its carton.



C. Thermal Printer

The only thermal printer provided by InBody can be used. Thermal printer should be connected to the serial port and it can be also used together with a regular printer. Please contact to a local distributor of InBody for further information.

D. Lookin' Body

Lookin'Body is a database management software, which stores the measurement results generated by InBody230. In addition, Lookin'Body keeps track of the measurement history of patients as well as illustrating the results by period and category, with a lot of visual explanations. Lookin'Body will help you provide more valuable consultation to your clients.

System requirements for installation are:

- Operating system : Microsoft Windows 2000/XP compatible
- CPU : IBM-PC compatible computer with Intel Pentium III 700MHz or higher
- Hard disk : 800MB or more of available hard-disk space
- Memory (RAM) : 256MB or more recommended
- Graphic cards and monitor: Screen resolution 1024 768, color depth 16 bit or higher
- Input devices : Keyboard and mouse
- Communication : Serial port (RS-232C)

A white line-art illustration of an InBody 230 bioelectrical impedance analysis (BIA) scale. The scale has a flat base with four feet, a vertical column, and a control panel at the top. The control panel features a small LCD screen, a numeric keypad, and several function buttons. Two handgrips are attached to the vertical column. The text 'InBody 230' is printed vertically on the column. The background is a light blue gradient.

Appendix

1. More about the InBody230
2. Classifications
3. Specifications
4. Worldwide Patents
5. Manufactures Warranty

1. More About the InBody230

A. How does BIA work?

The Bioelectrical Impedance Analysis (BIA) method is based on the fact that the human body consists of conductors, and non-conductors.

Generally 50~70% of the human body consists of water which functions as a conductor, whereas body fat functions as a non-conductor.

The classic BIA method measures the impedance of the whole body on the assumption that the human body can be considered a cylinder for application of this model. If A is the cross sectional area, and L is the length, the impedance of the cylinder can be expressed as follows.

$$Z = \rho \frac{L}{A} \quad (\rho = \text{resistivity})$$

If both sides are multiplied by L,
We get the new expression as follows.

$$V = \rho \frac{L^2}{Z} \quad (V(\text{Volume}) = A(\text{Area}) \times L(\text{Length}))$$

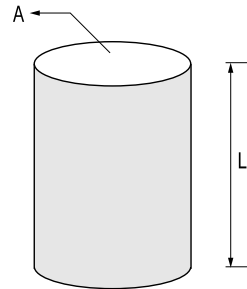

According to this expression, if we know the L and the impedance value, we get the volume. That is to say, if we know the height of the human body (acting as a conductor), and know the impedance value, we can get the volume of body water. Here, the volume of represents examinee's height. Therefore, the two directly used variables in body composition analysis are impedance and height.

The principle of InBody230's body composition analysis is explained by the following; the volume of body water, an electrolyte, is calculated first with measured impedance value. Then, we can get the value of fat free mass using the volume of body water. Body fat mass is determined by deducting the lean body mass from the measured weight.

Height should be entered by the user. Weight can be directly measured on the InBody230.

B. Core Technology

InBody230, the most advanced Body Composition Analyzer available, utilizes state of the art technology, providing accurate reproducible data and diverse composition analysis that is of great used to professionals. This new technology is patented worldwide. The following are key features that make the InBody230 extremely convenient, timely, and most importantly, accurate.

(1) Tetrapolar 8-Point Tactile Electrode

It was a complex and inconvenient procedure to attach and detach the electrodes to a specific spot every time. Trained technicians were needed for each measurement. The InBody230 uses tactile electrodes to void the possibility of errors and inaccuracies resulting form the above procedure. The 8-point Tactile Electrode method enables the InBody230 to efficiently produce accurate data every time.

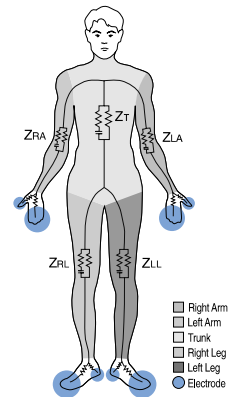

(2) Segmental Analysis

There are some technology that is able to estimate the body composition separately, but there is no technology which can really measure it separately. Segmental measurement is the technology that assumes the body as five cylinders of four limbs and trunk and measure impedance of these parts separately. Segmental body composition analysis provides segmental measurement of body water, muscle mass, and fat free mass. Furthermore, the analysis is highly accurate because the measured value of a certain part does not affect the measurements of other segments. It is because body composition analyzer lacks accuracy in measuring body fat and can't figure out the patient's exact shape that it needs empirical references to correct inaccurate measured values. But, InBody with the technology of segmental analysis can exactly figure out difference by gender, aging, disease and ethnic without any empirical estimation. Based on the fact that fat free mass (FFM) consists of about 73.3% of body fluid, it can be concluded that the distribution of body fluid reflects the distribution of FFM. Because InBody can analyze the segmental body fluid distribution—each arm, trunk, and each leg separately, it can examine a patient's segmental development.

C. Outputs

Weight

Total Body Water,

Fat Free Mass,

Body Fat Mass,

Skeletal Muscle Mass,

BMI,

Percent Body Fat,

Waist-Hip Ratio(WHR)

Basal Metabolic Rate(BMR)

Fat Control,

Muscle Control,

Segmental Percent Body Fat(Right arm, Left arm, Trunk, Right leg, Left Leg),

Segmental Body Fat(Right arm, Left arm, Trunk, Right leg, Left Leg),

Segmental Lean Mass(Right arm, Left arm, Trunk, Right leg, Left Leg)

Impedance of Each Segments & Frequencies

2. Classifications

This product is classified as the following:

- Shock Protection: Class I equipment.
- Degree of Protection Against Electric Shock: Type BF Applied Part.
- Degree of Protection Against Harmful Ingress of Water: Ordinary equipment (enclosed EQUIPMENT protection against ingress of water)
- Degree of Safety in the Presence of Flammable Anaesthetic Mixture with Air or With Oxygen or Nitrous Oxide: Not suitable for use in the presence of a flammable anaesthetic mixture with air or with oxygen or nitrous oxide.
- Mode of Operation: Continuous operation.

3. Specifications

Bioelectrical Impedance(BIA) Measurement Items	Bioelectrical Impedance(Z)	10 Impedance Measurements by Using 2 Different Frequencies (20 _{KHz} , 100 _{KHz}) at Each of 5 Segments (Right Arm, Left Arm, Trunk, Right Leg, Left Leg)
Electrode Method	Tetrapolar 8-Point Tactile Electrode System	
Measurement Method	Direct Segmental Multi-frequency Bioelectrical Impedance Analysis Method ;DSM-BIA Method	
Body Composition Calculation Method	No Empirical Estimation	
Outputs	Weight, Skeletal Muscle Mass, Body Fat Mass Total Body Water, Fat Free Mass BMI, Percent Body Fat, Waist-Hip Ratio(WHR) Basal Metabolic Rate (BMR), Fat Control, Muscle Control Segmental Analysis of Fat and Lean (Right arm, Left arm, Trunk, Right leg, Left Leg), Impedance of Each Segment. Exercise Planner(Optional)	
Applied Rating Current	330 μ A	
Adapter	Power Input	AC100-240V, 50/60Hz, 1.2A
	Power Output	DC 12V, 3.5A
Display Type	320 × 240 LCD(color)	
Input Interface	Key pad	
External Interface	RS-232C 1EA, USB Slave 1EA, USB Host 1EA	
Compatible Printer	Laser/Inkjet Printer (with PCL 3 or above, the printers recommended by InBody) , Thermal Printer (Optional)	
Dimensions	356(W) × 843(L) × 984(H) : mm 14.0(W) × 33.2(L) × 38.7(H) : inch	
Machine Weight	14.5kg(32lbs.)	
Measurement Duration	30 seconds	
Operation Environment	10 ~ 40 °C(50 ~ 104 °F), 30 ~ 75%RH, 70 ~ 106kPa	
Storage Environment	-20 ~ 70 °C(-4 ~ 104 °F), 10 ~ 95%RH, 50 ~ 106kPa	
Weight Range	10 ~ 250kg(22 ~ 551lbs.)	
Age Range	3 ~ 99years	
Height Range	85 ~ 220cm(2ft. 9.5in. ~ 7ft. 2.6in.)	

* Specifications are examinee to change without prior notice.

4. Worldwide Patents

1998. 02 U.S. patent

Apparatus and method for analyzing body composition based on bioelectrical impedance analysis (US 5,720,296)

2000. 08 Canadian patent

Apparatus and method for analyzing body composition using a new electrode system based on bioelectrical impedance analysis (CN 2,225,184)

2001. 07 U.S. patent

Apparatus for analyzing body composition based on bioelectrical impedance analysis and method thereof (US 6,256,532B1)

2002. 03 Japanese patent

Apparatus for analyzing body composition based on bioelectrical impedance analysis (3,292,373)

2003. 06 U.S. patent

Apparatus for analyzing body composition using novel hand electrodes and method thereof (US 6,400,983B1)

2002. 09 EPO patent (Germany, France, U.K. and Italy)

Apparatus and method for analyzing body composition using a new electrode system based on bioelectrical impedance analysis (EP 0,835,074)

5. Manufacturer' s Warranty

Product:

Serial Number:

Purchase Date:

Institute Name:

InBody Co., Ltd. [HEAD OFFICE]

InBody Bldg., 54, Nonhyeon-ro 2-gil, Gangnam-gu, Seoul 135-960 KOREA

TEL: +82-2-501-3939 FAX: +82-2-578-2716

Website: <http://www.inbody.com>

E-mail: info@inbody.com

1. InBody guarantees that the product has been approved through qualified test procedures under severe conditions.
2. The one year manufactures warranty begins on the date of purchase.
3. During the one year warranty period, InBody remedies any original defect in material or workmanship.
4. The following defects or malfunctions will not be covered under the one year warranty:
 - Any defect caused by use's fault.
 - Any defect or damage caused by not following the instructions described in the user' s manual
 - Andy defect or damage caused by natural disasters (storm, flood, earthquake, etc.)
 - Any defect or damage caused by disassembly of the InBody230 or by modifying internal parts or program by unauthorized personnel.
5. An extended warranty may be purchased by executing an extended warranty contract after the initial warranty period.
6. No return is allowed after a product is opened. The proof of purchase must be accompanied before requesting service.
7. Please contact authorized personnel for any service calls.
8. The shipping stuff should be stated in here for malfunction or replacements.
9. Shipping charge is the customer's responsibility.

InBody www.inbody.com

©1996- InBody Co., Ltd. All rights reserved.