

InBody 720

THE PRECISION BODY COMPOSITION ANALYZER

User's Manual

InBody

© 1996- InBody Co., Ltd. All rights reserved.

This user's manual cannot be copied, translated or transformed into different media without a prior written consent from InBody Co., Ltd, according to the copyright laws. This user's manual and product pertinent to this manual may have misprints or technical flaws, which can be modified without prior notice to the readers. InBody is not liable for any damage caused by a failure to meet the requirements in this user's manual.

InBody Co., Ltd. [HEAD OFFICE]

InBody Bldg., 54, Nonhyeon-ro 2-gil, Gangnam-gu, Seoul 135-960 KOREA

TEL: +82-2-501-3939 FAX: +82-2-578-2716

Website: <http://www.inbody.com>

E-mail: info@inbody.com

InBody, Lookin Body are the registered trademarks of InBody Co., Ltd.

The names of the companies and products in this manual other than those of InBody Co., Ltd. are the trademarks of the companies. Stating the products of other companies is strictly for the purpose of providing information, and not to guarantee or recommend the products. InBody is not responsible for the performance or the use of these products.

InBody reserves the right to modify the dimensions or exterior of InBody720 to improve the quality of the products, without consent of the customer.

HOW TO USE THIS MANUAL

This user's manual explains the functions of InBody720 in the way that is very detailed and easy to understand. Follow the instructions below for effective use of this manual.

1. Read this manual thoroughly before using the equipment.
2. Take a few moments to look at the pictures of diagrams of the equipments to understand the configuration of the equipment.
3. Read the "Chapter 4 Problems and Solutions" before requesting a warranty service.
4. Read the "Chapter 5 Consumables" when you want to purchase supplies or optional devices.
5. Email or phone us if you experience any inconvenience when using the equipment.
Forward any clinical inquiries at:
E-mail: info@inbody.com TEL: +82-2-501-3939
6. Read signs of warning, precautions and notes carefully. The followings are the visual representations of these signs.



Important information to warn you of situations which might cause an imminent risk of death and/or major injury if instructions are not carefully followed.



Important information to warn you of situations which might cause major injury and/or damage to property if instructions are not carefully followed.



Important information to warn you of situations which might cause minor injury and/or damage to property if instructions are not carefully followed.



Important helpful information for operating InBody720.

SAFETY INFORMATION



The following is important information to warn you of situations which might cause an imminent risk of death and/or major injury if instructions are not carefully followed.

1. Never use this unit in combination with the following medical electronic device.
 - Medical electronic implants such as pacemakers
 - Electronic life support systems such as an artificial heart/lung
 - Portable electronic medical devices such as an electrocardiograph
 - This equipment may cause the above mentioned medical electronic devices to malfunction
2. Do not operate within 1 meter from shockwave or microwave therapy equipment. Avoid simultaneously connecting subjects to InBody720 and high frequency surgical equipment.



The following is important information to warn you of situations which might cause major injury and / or damage to property if instructions are not carefully followed.

1. Do not operate within 1 meter of other running medical electronic equipment. This will result in electromagnetic interference or possibly other interference between InBody720 and that equipment.
2. To prevent fire caused by electricity, always use the standard fuse.
3. To avoid electric shock, be sure to avoid contact between InBody720 and any kind of external connector or other device that might be connected to a power source.
4. Do not operate this equipment if it has a damaged power cord or plug, if it is not working properly, or if it has been damaged.
5. Do not immerse power cord in water.
6. Do not touch signal parts for external communication such as the parallel port, a serial port, etc. and a human body at the same time.
7. Do not dismantle the equipment. Internal parts are not for customer use. If the unit is dismantled, the warranty is void, and service costs will be charged to you. If service is required, contact InBody or the supplying agency.
8. Individuals with any kind of contagious disease or any kind of injury to the palm or sole must not use or come in contact with this product.
9. Never start weight reduction or exercise therapy without the instructions of a physician or a specialist. Self-diagnosis may damage your health condition. Consult with your physician before using when pregnant.
10. This equipment is specifically designed to analyze body composition. Use the equipment only for its intended use as described in this manual.



The following is important information to warn you of situations which might cause minor injury and / or damage to property if instructions are not carefully followed.

1. While moving, installing or using this product, be sure to protect it against any physical shock or damage. Always use the packing material and the original shipping carton when moving or transporting this product.
2. Always operate this product within prescribed ranges of temperature, humidity, and pressure. Operating in ranges outside of those specified may affect the operation of this product, and may cause malfunction.
3. Follow local governing ordinances and recycling plans regarding disposal or recycling of device components.
4. Be careful not to spill or drop any residues of food or beverages on this product. It may cause serious damage to the electronic components.
5. Install or locate the equipment only in accordance with the provided installation instructions.
6. Do not use this equipment near water.
7. This equipment should be serviced only by qualified service personnel. Contact InBody for examination, repair or adjustment.







Important helpful information for operating InBody720.









1. This equipment generates, uses and can radiate radio frequency energy and if not installed and used in accordance with the instructions, may cause harmful interference to other devices in the vicinity. However, there is no guarantee that interference will not occur in a particular installation. If this equipment does cause harmful interference to other devices, which can be determined by turning the equipment off and on the user is encouraged to try to correct the interference by one or more of the following measures:
 - Reorient or relocate the receiving device.
 - Increase the separation between the equipment.
 - Connect the equipment into an outlet on a circuit different from that to which the other device(s) are connected.
 - Consult the manufacturer or field service technician for help.
2. This product has been designed, manufactured, and inspected under the full quality assurance system of InBody. InBody fulfills European MDD (Medical Device Directive), and InBody720 has acquired the CE conformity marking.
3. InBody720 fulfills the Standards of IEC60601-1 (EN60601-1), Safety of Electric Medical Equipment. In addition, InBody720 complies not only with the Level A for Noise Immunity but also with Level A for Noise Emission by the Standard IEC60601-1-2 (EN60601-1-2), Electromagnetic Compatibility requirements.

INDICATION & SAFETY SYMBOLS

A. Indication

- 2005  Manufacturing Year
-  9pin serial port, (RS232C, Male)
-  Ethernet port (10/100Base-T)
-  USB port (Version 1.1)
-  IEEE 1284 (25pin Parallel), Female (PCL 3, or above; printer)

B. Safety signs

-  Dangerous high voltage
-  Danger / Warning / Caution / Note (refer to the safety information)
-  Fuse specification
-  Equipotential terminal
-  BF type equipment
-  Alternating Current
-  Turn on the power
-  Turn off the power

INTRODUCING InBody720 THE BODY COMPOSITION ANALYZER.

Human body consists of body water, protein, body fat and mineral. The four elements are the fundamental ingredients constituting the body and the balance between them is essential to our health. Body composition analysis is to quantify and measure these ingredients.

In the past, diagnosing obesity was focused on how we looked outside, without considering the balance among body water, protein, body fat and minerals. From the health point of view, body composition analysis that takes into account the balance between body water, protein, body fat and mineral makes more sense than diagnosing obesity based on how we look. In addition, this is where the body composition analyzer with high precision comes in.

InBody earned recognition in the international market for technical expertise demonstrated through InBody 2.0 and 3.0. Based on the experience and technicality accumulated over the last 10 years, InBody released the InBody720, taking the body composition analysis to a new height. The body composition analyzer InBody720 is accurate for all body types and for any possible distribution of body water, measuring the progress of clinical treatment, weight loss program or exercise therapies reliably.

Using a diverse range of frequency from 1kHz to 1MHz, the InBody720 measures the amount of body water accurately. Particularly, the InBody720 is the first version to use the reactance analysis method, which is the more advanced technology for the body composition analysis than those used in previous versions. Professional-looking exterior, high-definition monitor and new level of expandability of the InBody720 that were not found in the previous body composition analyzers will usher you into a new chapter of body composition.

InBody strives to be your partner for health. We are committed to developing high-quality products through transparent management and continuous research and development.

Kichul Cha, CEO

CONTENTS

HOW TO USE THIS MANUAL	I
SAFTY INFORMATION	III
INDICATION & SAFTY SYMBOLS	V
INTRODUCING InBody720 - THE BODY COMPOSITION ANALYZER	VI
Chapter 1 Installation and Maintenance	
1. Contents in a Carton	1-2
2. Exterior and Functions	1-4
3. Installation Instructions	1-10
4. Transportation	1-13
5. Repacking	1-14
6. Maintenance	1-15
Chapter 2 Management & Results Description	
1. Cautions Before Measurement	2-2
2. Exterior and Function of Keypad	2-3
3. Power Connection & Getting Started	2-4
4. Initial Screen and Input	2-6
5. Personal Profile	2-7
6. Proper Posture	2-9
7. How to Operate the Equipment	2-11
8. Results	2-14
Chapter 3 Setup Establishment	
1. Setup Menu	3-2
2. Quick Setup	3-7
3. DATABASE	3-8
4. Modification Example	3-10
Chapter 4 Problems and Solutions	
1. Error Messages	4-2
2. Troubleshooting	4-3
3. Frequently Asked Questions (FAQs)	4-5
4. Customer Service Information	4-7
Chapter 5 Consumables	
1. Consumables	5-2
2. Basic Equipment	5-3
3. Options	5-4
Appendix	
1. More About InBody720	Appendix-2
2. Classifications	Appendix-4
3. Specifications	Appendix-5
Manufacturers Warranty	Appendix-6

Chapter 1 Installation and Maintenance

1. Contents in a Carton
2. Exterior and Functions
3. Installation Instructions
4. Transportation
5. Repacking
6. Maintenance

1. Contents in a Carton

This product consists of the following units. Make sure your products include all the units.

A. Product units

- ① InBody720
- ② Hinge cover + hexagonal wrench (6mm) 1 each
- ③ Fuse holder (1 unit) + fuse (F2.5AL250V; 2 units) + spare fuse 2 units
- ④ Cables (AC 250V 10A 1.8m)
- ⑤ The user's manual CD + Easy Installation Guide 1 each
- ⑥ Main Body Cover 1 unit(option)



B. Package

- ① Packaging Box(1250 × 450 × 280; mm, W × L × H) 1 unit
- ② Upper pad 2 units
- ③ Support pad 1 unit
- ④ Head pad 1 unit
- ⑤ Accessory bag 1 unit
- ⑥ Elastic band 2 unit

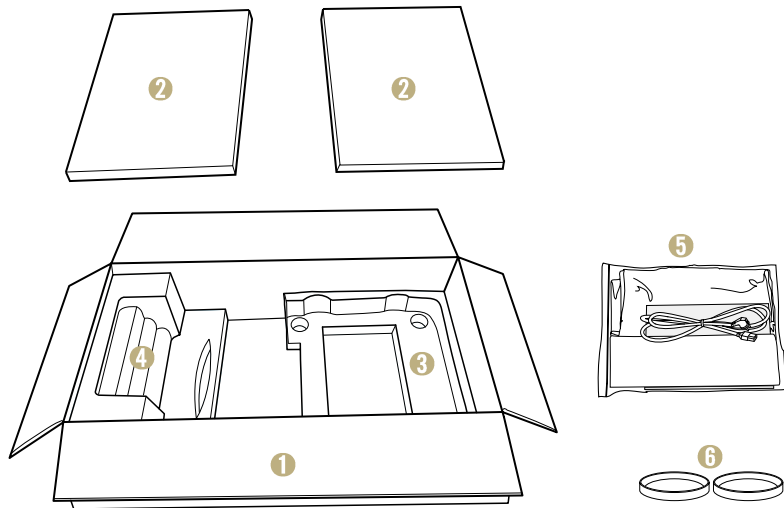

To reduce the physical impact on the equipment, use the wrapping material provided by the InBody during shipment or transit. For information on how to relocate the equipment, refer to the "Chapter1, Section 4. Transportation."



Keep the wrapping material with you after installation in the event of relocation.

2. Exterior and Functions

This section introduces the name of parts and their functions. Before installation, check for cracks on the case of equipment.

- A. Operation Part
- B. Upper Part
- C. Lower Part
- D. Rear Part

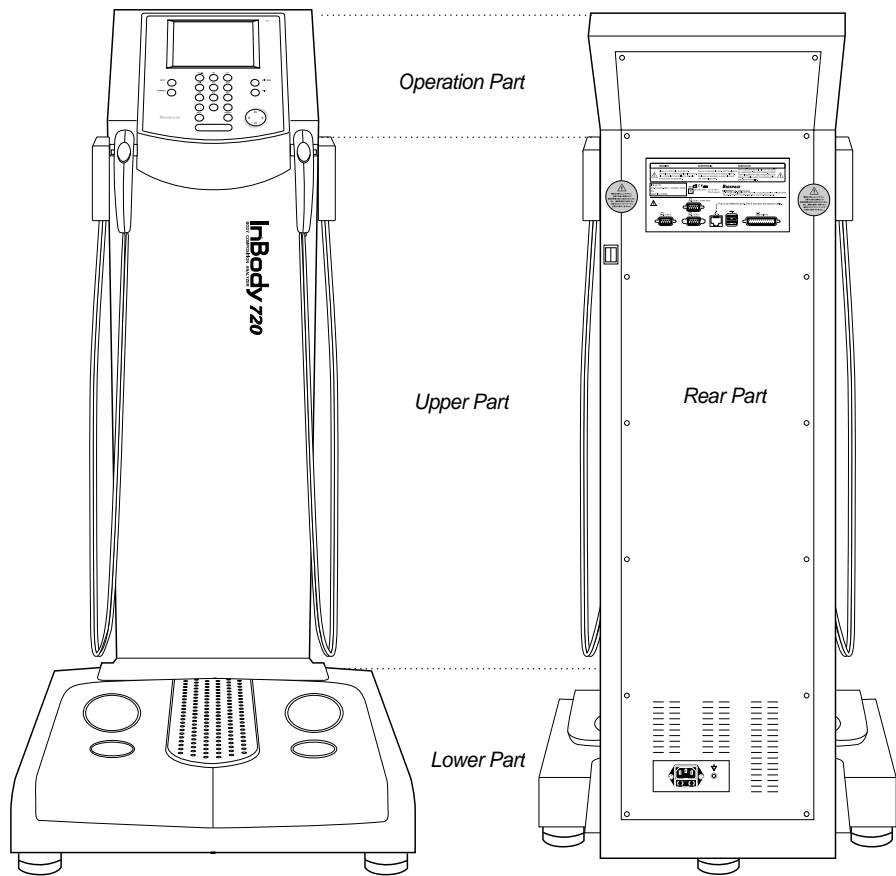

A. Operation part

- 1 LCD monitor (640 X 480 TFT Color LCD)
The monitor displays the status of progress, message or test results.
- 2 Keypad (20 buttons)
The keypad is divisible into input buttons and function buttons. The buttons are used to input data required for body composition analysis, set up the operating environment or to print out test results.



B. Upper part

- 1 Hand Electrode Holder
Place the hand electrode while not in use.
- 2 Thumb Electrode
This is the area where the subjects press their thumb on to come into contact with electricity during testing.
- 3 Palm Electrode
The subjects put their palm on this part to come into contact with electricity.
- 4 Hand Electrode Cable
The hand electrode cable is connected to the circuit that transfers voltage and electric current.
- 5 Body Stand
The body stand contains the circuit board.

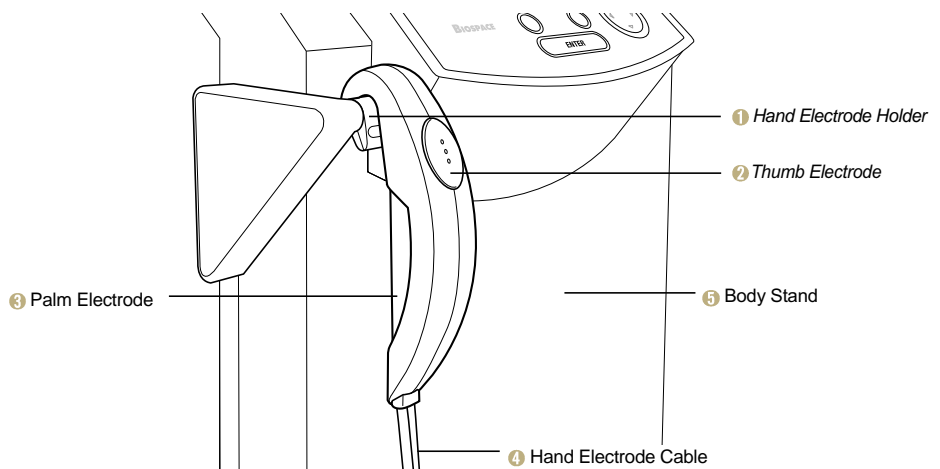

C. Lower part

① Front Sole Electrode

The subject stands on the foot electrode to come into contact with electricity during testing.

② Rear Sole Electrode

The subject put their heels on this foot electrode to come into contact with electricity during testing.

③ Base Frame (Loadcell)

The loadcell is connected to the base frame where the subject stands on.

④ Hinge Cover

The hinge cover with hinges in the middle separates the area connecting the upper and lower part of the equipment. It can come off the equipment and be folded into half for easy transportation. A body wrench (6mm) is attached underneath the hinge cover.

⑤ Level Indicator

The level is in the middle of the lower part, which is covered by the hinge cover. Check out with the level to determine whether the equipment is level.

⑥ Leveling Screw

The equipment has five legs screwed into the equipment. You can use the legs to adjust the height and level of the equipment.

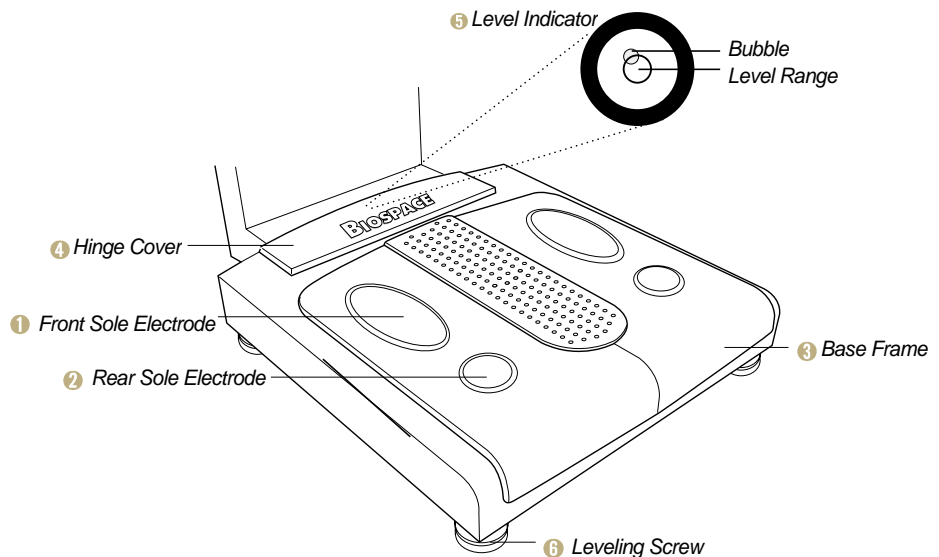

D. Rear part

(1) Back Cover

The back cover should be opened only for the purpose of repair. Only the InBody s technicians are allowed to open the cover.



<Warning sticker>

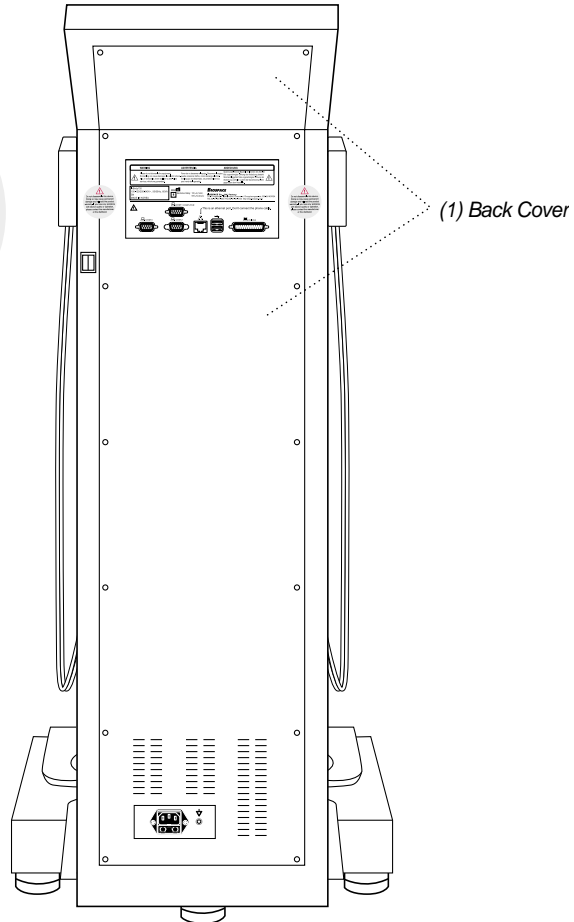

InBody is not responsible for damages done on the product or injury caused by the user's unauthorized opening of the back cover.



InBody is not responding to any request for repair or upgrade, when damage is done on the warning sticker or there is any indication that the back cover was previously opened. Do not open the back cover in any case.

(2) Control & Connection Unit

This unit allows the equipment to connect to peripherals such as computers and printers as well as transferring data back and forth.

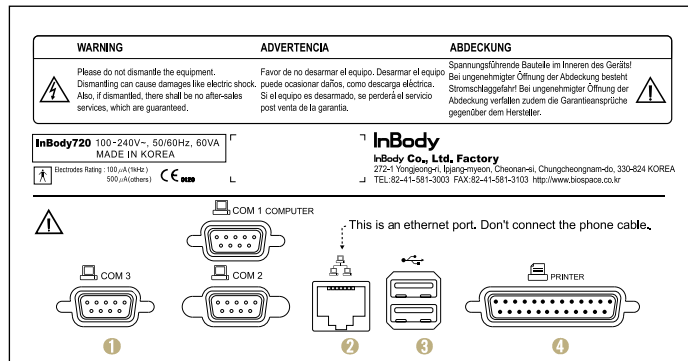

① 9pin Serial Port, Male (RS-232C)

Com 1 port is used to connect to the personal computer that runs the Lookin 'Body.

Com 2 port is used for an additional peripheral.

Com 3 port is used for an additional peripheral.

② LAN Port (10/100 Base-T)

Through LAN cable, the equipment can communicate with the external systems including computers. The LAN interface supports both 10Mbps and 100Mbps Ethernet connection.

③ USB Port (Version 1.1)

InBody720 communicates with external devices such as computers and printers through the two USB ports and cables. You can use either of the two USB ports interchangeably. As of now, the equipment supports only printers as a USB device.

④ 25pin Parallel Port (IEEE 1284)

The 25pin parallel port is used to connect to printer. If you intend to use USB printer, connect it to the USB port.



NOTE

Only the peripherals provided by InBody can be connected to InBody720. For any inquiry about peripherals, contact InBody.

(3) Power & Safety Unit

① Power Socket

Plug the 3-pin plug to the power socket to supply the power to the equipment.

② Fuse Socket

The fuse holders (two fuses) are embedded in the equipment.

③ Equipotential Terminal

The equipotential terminal can be connected to the external equipotential line to prevent danger caused by the difference in the potentials between the other devices.

④ Power switch

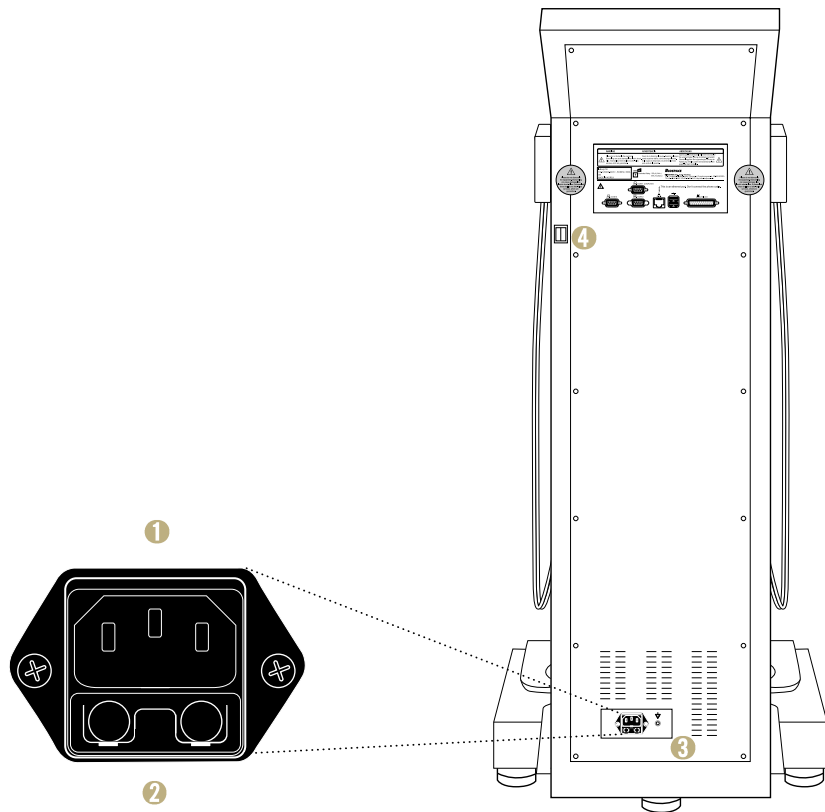

3. Installation Instructions

A. Workplace Requirements

- (1) Location: Indoor only. Any outdoor area where the equipment is to be located should meet all the environmental requirements.
- (2) Operating environment: 10 °C~40 °C(50 °F ~ 104 °F), 30%~75% RH, 70~106kPa
- (3) Power supply: 100 - 240V, 50/60Hz

B. Unpacking and Assembling

(1) Remove the pads

- ① Unpack the carton and remove the (a), (b) upper pads.

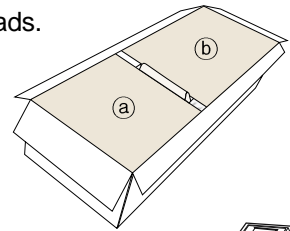

- ② Straighten the equipment as pulling it forward at the same time.

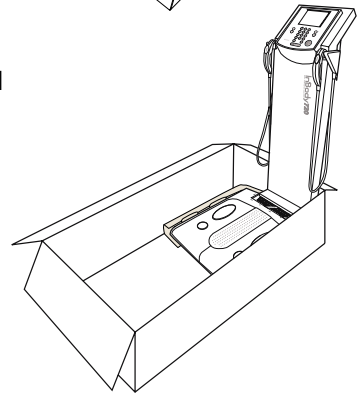

(2) Place the equipment

- ① Tighten the screws connecting upper and lower part with a hexagonal wrench. The hexagonal wrench is located underneath the hinge cover.

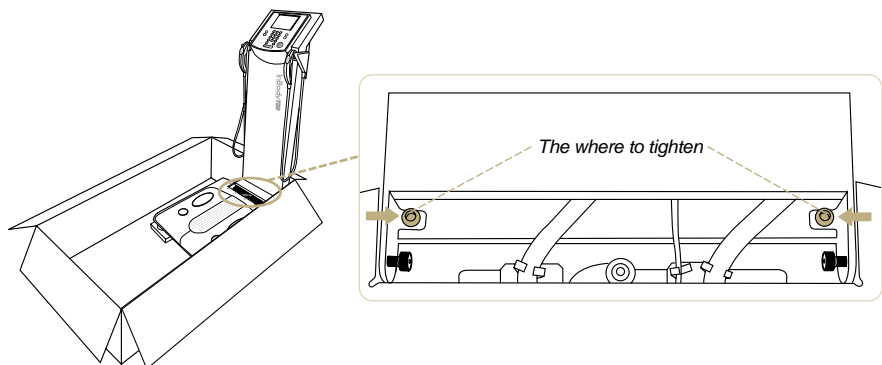

- ② Hold the upper part and center of lower part by two people and take the equipment out of the carton. Place the equipment at desired area and tighten the 4 screws connecting upper and lower parts with a hexagonal wrench.

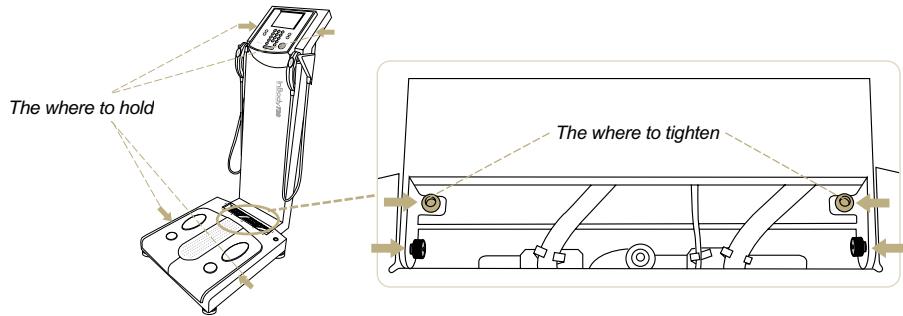

(3) Level InBody720

The level indicator is located at the center of connecting part and leveling screws under the lower part. Check the level indicator. You may adjust 5 leveling screws under the lower part to level the equipment.

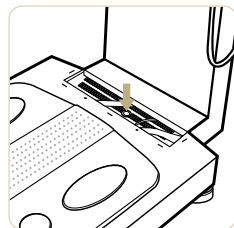

Unleveled state

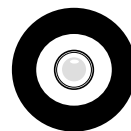

Leveled state

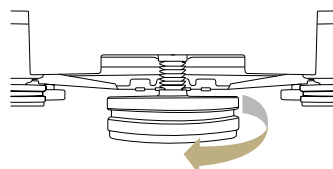

<Raising>

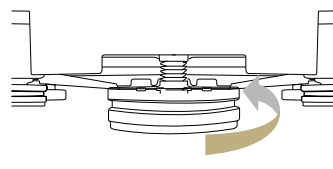

<Lowering>

(4) Close the hinge cover

- ① Attach the hexagonal wrench back to the underneath of hinge cover.

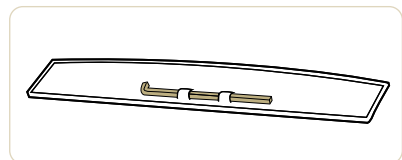

2 Close the hinge cover.

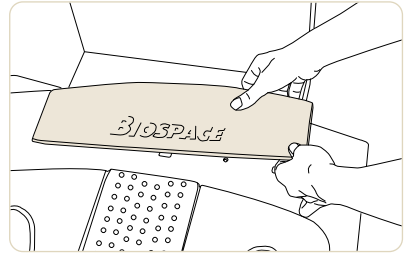

3 Lift up the rear part and remove the elastic bands pulling the hand electrode cables.

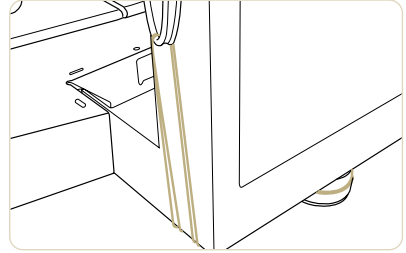

(5) Insert the fuse and connect the power

1 Insert the fuse holder which contains the rated fuses into the a fuse socket.



2 Connect the power cable into the b power socket.

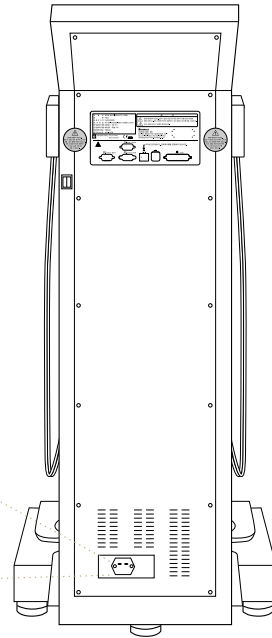
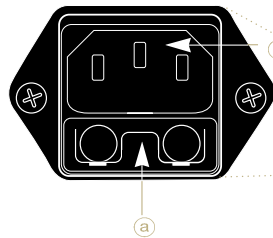

Put the spare fuses in a small plastic bag and attach it to the back of the equipment by tape. When the fuse is broken, you can easily replace it with the spare fuse.

4. Transportation

It is recommended not to move the equipment around once it is installed. If it is inevitable to relocate the equipment, follow the safety requirements that follow.

- (1) Turn the power off and pull the plug off the power outlet before moving.
- (2) Take all the possible measures to ensure no physical impact is made on the hand electrode.
- (3) Adjust the level of the equipment using the legs of the equipment after moving.
- (4) Tighten the connection between the lower and upper part with the hexagonal wrench.

A. Environmental requirements

- Temperature: -20°C~70°C (-4°F~158°F)
- Relative humidity: 10% ~ 95%
- Air pressure: 50kPa~106kPa

B. Transporting before installation

Before installation, the equipment is in a packaging box provided by InBody. Use a carrier to move the box over or have two people from both sides for safe transportation.

C. Transporting after installation

It is not recommended to move the equipment installed by InBody or the authorized distributors of InBody. If it is inevitable to move the equipment, repack the equipment with the box and wrapping material the equipment came in, to keep the equipment from being damaged during transportation.



After moving the equipment, adjust the level of the equipment using the level indicator and legs of the equipment. The level of the equipment is crucial to accurate testing.

5. Repacking

Be sure to turn off the power switch and unplug the power cable before repacking. Be careful not to damage foot and hand electrodes while repacking.

- 1 Turn off the power and remove the power cable.

- 2 Use elastic bands to hold hand electrode cables. Lift up the rear end slightly, hook the elastic band to the rear level screw, pass it through the cable and hook it again to the rear level screw.

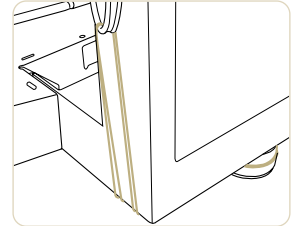

- 3 Place the support pad on the bottom of a carton and put InBody720 on the top.

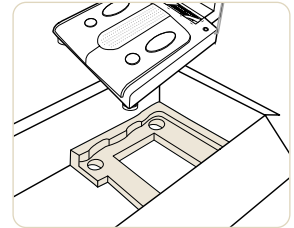

- 4 Place the head pad on a carton.

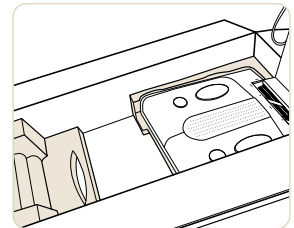

- 5 Open the hinge cover and loosen the 4 screws.

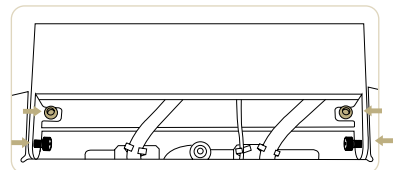

- 6 Fold the upper part and put it in the carton.

- 7 Insert the accessory bag in the carton.

- 8 Put upper pads on the top.

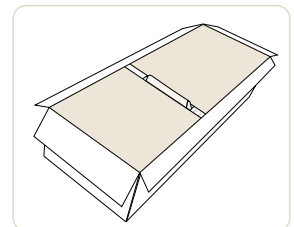

- 9 Close the carton box and seal it with tape.

6. Maintenance

- (1) Do not pull hand electrode cable from the hand electrode or from the mainframe of the equipment. Treat it with care.
- (2) Do not leave anything on the stand or make a physical impact on it.
- (3) Leave the power off, if you do not use the equipment for over a day.
- (4) Pull the plug off, and cover the equipment, if the equipment is not used for an extended period.
- (5) Do not move the equipment with the power on.
- (6) Do not spill drinks or food into the equipment. Substance getting into the equipment will cause a critical damage on the equipment.
- (7) Wipe up gently the case of the equipment with a cloth with no piles once every week. Do not scratch the LCD monitor while cleaning.
- (8) To discard packaging material of InBody720, follow the garbage disposal regulations on packaging materials.

Chapter 2 Management & Results Description

- 1. Cautions Before Measurement**
- 2. Exterior and Function of Keypad**
- 3. Power Connection & Getting Started**
- 4. Initial Screen and Input**
- 5. Personal Profile**
- 6. Proper Posture**
- 7. How to Operate the Equipment**
- 8. Results**

1. Cautions Before Measurement

To observe changes of the human body through body composition analysis, it is crucial to perform the analysis each time under the same conditions, temperature, posture, etc. Bear in mind, the following factors affect the result of body composition analysis, and as a result, affect the reproducibility of analysis.

- (1) Do not exercise or perform any physical tasks. If they have already been physically active or experienced any sudden body movements, a temporary change in body composition will result.
- (2) Do not eat before measurement.
If the subject already ate something, please wait for 2 hours for digestion.
- (3) Do not take a bath or shower before measurement.
Perspiring (sweating) results in a temporary change in body composition.
- (4) Perform the measurement under normal temperature conditions (20~25 °C, 68~77 °C).
If the ambient temperature is too high or too low, the human body responds, resulting in temporary changes in body composition.
- (5) Perform the measurement after urination or excretion, if possible.
Residues inside the human body are interpreted as fat mass.
Waste in the body means the analysis will be less accurate.
- (6) Measurement should be done before mid-day.
The longer we stand, the more body water flows downward and this process speeds up in the afternoon.

2. Exterior and Function of Keypad

The keypad as illustrated below is divided into two sections by their functions.

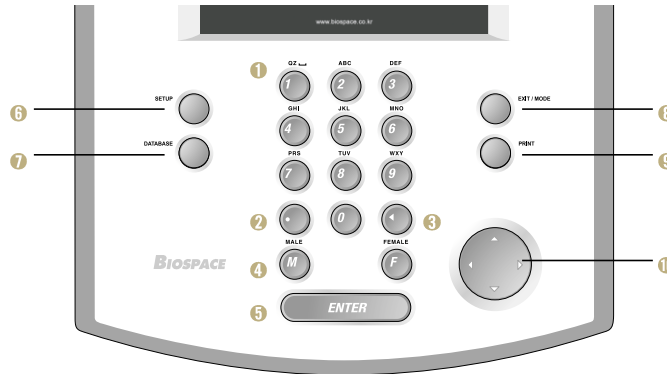

A. Input Button (15 buttons)

1 Number Buttons (0~9) / Alphabet Buttons (A ~ Z)

The input buttons are used to enter numeric and character data such as the subject's age, height and I.D.. When a button is pressed, the LCD screen shows the numeric and then character representations of the button in the alphabetical order. For instance, press the button 2, then you will see a set of numeric and character representations assigned to the button showing up in the pre-determined order of 2, A, B and C.

2 Point Button

The point button is used to enter a decimal point or period, for height, age, I.D. and weight.

3 Backspace Button

This button is used to delete data that was entered.

4 Gender Selection Button: F (Female), M (Male)

This button is used to enter the gender of the subject.

5 Enter Button

This button is used to tell the system that data input is complete or move on to the next section.

B. Function Button (5 buttons)

6 SETUP

This button is used to update or modify the user environment.

7 DATABASE

This button is used to view the archives.

8 EXIT / MODE Button

The EXIT / MODE button is used to modify the user environment easily in the startup window. And this button is used to stop the process that is in progress or go back to the previous process.

9 PRINT Button

This button is used to print the test results. InBody720 only allows for printing of the test results that belong to the last subject tested. You can print multiple copies of the results sheet, until a next subject steps onto the equipment to have his/her personal data entered and the test results of the previous subject is no longer in the memory.

10 Direction Buttons

The direction buttons consist of "up," "down," "left" and "right" buttons. The arrow signs on top of the buttons indicate the directions where control will be heading.

3. Power Connection and Getting Started

- (1) Plug the power cable to the outlet.
- (2) Once power is turned on the equipment, the LCD monitor displays a sequence of characters, indicating the sequential process of loading up the operating system to the system. This is equivalent to the process through which PC loads up windows to the memory and gets the operating systems ready for the user.
- (3) As the logo comes up as shown below, the system boots itself up automatically. During this boot-up period that takes up to 5 minutes, InBody720 tests its internal system, sets the initial weight at zero for the scale, adjusts the internal circuits and determines whether the peripherals listed in the setup are still in use. The results of this initialization process will be displayed on the monitor.



NOTE

Do not put weight on the lower part of the equipment from the point when you turn the power on to when the InBody720 finishes booting process. If you go on the stand or leave a heavy object on it, the system reports error with initializing the weight at zero, resulting in inaccurate measurement.



CAUTION

When connecting peripherals (printers and other optional devices) to the InBody720, turn on the peripherals and then the InBody720. When turning the power off, turn off the InBody720 first before turning off the peripherals. This process will minimize the harm on the equipment caused by electric shock.

- (4) When the system boots up, the initial screen comes up, allowing the user to enter data into the system.

I.D.	AGE	HEIGHT	GENDER	WEIGHT
		cm	F	kg

Obesity Diagnosis		Under	Norm.	Over	Edema ECF/TBF ECV/TBW
WEIGHT					
SMM					
FAT					
VFA					
WHR					

Nutritional Evaluation				Weight Management			
PROTEIN	<input type="checkbox"/>	<input type="checkbox"/>	<input type="checkbox"/>	WEIGHT	<input type="checkbox"/>	<input type="checkbox"/>	<input type="checkbox"/>
MINERAL	<input type="checkbox"/>	<input type="checkbox"/>	<input type="checkbox"/>	SMM	<input type="checkbox"/>	<input type="checkbox"/>	<input type="checkbox"/>
FAT	<input type="checkbox"/>	<input type="checkbox"/>	<input type="checkbox"/>	FAT	<input type="checkbox"/>	<input type="checkbox"/>	<input type="checkbox"/>

Body Balance				Body Strength			
UPPER	<input type="checkbox"/>	<input type="checkbox"/>	<input type="checkbox"/>	UPPER	<input type="checkbox"/>	<input type="checkbox"/>	<input type="checkbox"/>
LOWER	<input type="checkbox"/>	<input type="checkbox"/>	<input type="checkbox"/>	LOWER	<input type="checkbox"/>	<input type="checkbox"/>	<input type="checkbox"/>
UPPER-LOWER	<input type="checkbox"/>	<input type="checkbox"/>	<input type="checkbox"/>	MUSCLE	<input type="checkbox"/>	<input type="checkbox"/>	<input type="checkbox"/>

Welcome to InBody

WEIGHT CONTROL
 Target Wt. kg
 Weight Ctrl. kg
 Fat Ctrl. kg
 Muscle Ctrl. kg

BMR	SCORE
kcal	points

Printer Lookin' Body
2004/07/01 SAT 09:23

4. Initial Screen and Input

The Initial screen in the InBody720 provides a variety of the functions for the convenience of the subject and the user. The configuration of Initial screen is categorized into four groups by function.



A. Personal Information Window

This area is where the personal information of the subject including I.D., number, height, weight and gender will be entered. Start entering the subject name or identification number. If you want to leave the name or identification number empty, press the direction button (▶) to move on to the age section.

B. Information Window

The information window displays message guiding the user with weighing the subject, test methodology, test procedure and error message. This window will help the subject and the user along the test, by providing detailed and specific information.

C. Analysis Result Window

Before a results sheet is printed out, the analysis result window displays the key figures from the analysis of the test. The figures shown in the window will be in a printed results sheet.

D. Status Window

The status window shows the listing of peripherals registered in the InBody720. And user can modify the user environment easily. The changeable items are weight adjustment, results sheet selection and mode.



NOTE

When power comes on, the InBody720 checks the settings of peripherals listed in the setup applet and display them in the status window. The setup applet checks the connection status of peripherals, before modifying them. If the peripherals are not physically connected to the InBody720 or it is turned off, the setup applet of the InBody720 does not set the status of that particular peripheral as "Enable."

5. Personal Profile

Age, height, weight and gender are the key personal information required to analyze the body composition. To reduce the probabilities of an error and to obtain reliable results, follow the instructions presented below.

A. I.D. (permissible range of input : 20 characters)

Use the numeric buttons to enter data. With each button press, numbers or alphabets are displayed in the sequence shown on the keypad.

B. Age (permissible range of input : 3years ~ 99years)

Use the numeric buttons to enter data. Age should be based on the western standard. For the subject of under 18 years of age, the user can include one decimal point in the age text field for more accurate testing. The decimal digit represents the number of months elapsed since the last birthday and should be decimal expressions of a fractional number with the denominator of 12. For example, the 16.5 years old can be translated into 16 years and 6 months old (6 months/12 months=0.5).

C. Height (permissible range of input : 95cm ~ 220cm ; 3ft. 1.4in. ~ 7ft. 2.6in.)

Use numeric buttons to enter height. Heights can have one digit under the decimal point. As the height the subject remembers might not be accurate, measure the height of the subject before conducting body composition analysis using the InBody720.

D. Gender

Female is selected as a default. Press the button of the gender of the subject. For men, press the “male” button and for female, press the “female” button.

E. Weight

When the subject steps on to the InBody720, the equipment weighs the subject immediately and the value for weight is automatically recorded into the weight of the personal information windows. To deduct the weight of clothes, go to the “Chapter 3 Setup Establishment” and then to the others setting or “Chapter 2 , Section 4 Initial screen and Input.”

I.D.	AGE	HEIGHT	GENDER	WEIGHT
MISUK HAN	39	159 _{cm}	F	65.9 _{kg}



After entering two digits for age and three digits for height, move on to the next text field. If you want to use the decimal digits for age and height, use the direction button (◀) to back to the previous text fields and enter the values for decimal digits. In entering weight, you can enter a certain number of decimal digits.

You can correct the data, when the input data is incorrect.

- ① Error occurs with key operation prior to the entry of data.
Press the backspace key (◀) to delete the entry and enter data again.
- ② Error occurs with the text field data entries before the current text field.
Use the direction button (◀) to move to the text field where an error occurs and press the backspace key (◀) to delete the existing data and re-enter data.
- ③ An error occurs in the Initial screen after data entry is completed.
Use the direction button (◀) to move to the text field you would like to go to. Press the backspace key (◀) to delete the existing data and re-enter data.
- ④ An error with data occurs while analysis is in progress.
Press the "EXIT / MODE" button to stop the analysis, as it is impossible to re-enter data at this point. Go back to the very beginning and start with weighing the subject.

6. Proper Posture

Observing the following methodology is essential to achieving reliable results and accuracy. Palms, fingers and soles should be in contact with electrode during the testing. Keep the following instructions in mind during testing.

A. How to hold hand electrodes

- (1) Four fingers should be touching the surface of the electrode as shown below.
- (2) Put the thumb lightly on top of thumb electrode and press the button gently. Throughout the test and analysis, the subject should gently hold the hand electrode.
- (3) If the subject's hands are a bit too small for hand electrode, pull the hand towards the thumb electrode so that the thumb can touch the button.

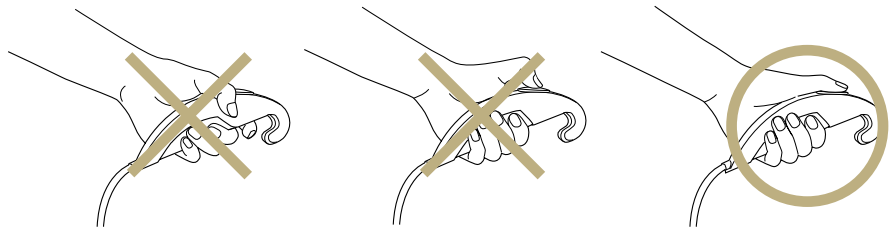

Do not press the button with the fingernails: fingernails may damage the electrodes and result in inaccurate test finding.

NOTE

B. How to stand on foot electrodes

- (1) Step on the foot electrode in barefoot.
- (2) Heels should land on the circular-shaped foot electrode, before the fore-foot hits the electrode.
- (3) The whole part of soles should be in contact with the foot electrode.

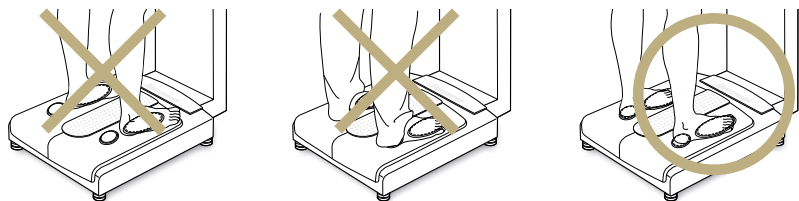

Do not have the hems of pants get in between the heels and electrode. As for the subject who has too small feet to cover the both electrodes, they should be able to touch at least part of both electrodes.

NOTE



If the subject's feet or hands are too dry, or has dead, hard skin built up, InBody720 may prompt the user to re-test the subject. In this case, wet the palms and soles with electrolyte tissue that comes with the InBody720 and re-test the subject.



When wetting hands and feet, keep the moisture on hands and feet from dripping to the electrodes. Excessive moisture may cause an erosion of electrode, which in turn may result in breakdown of the equipment. The electrolyte tissues provided by the InBody are specifically manufactured for InBody and thus is completely different from the generic wet tissues in the market. It is strongly recommended to use the electrolyte tissues specifically designed for InBody720.

C. Body Posture

During testing, the LCD monitors display information on body composition, allowing the subject to read the analysis from the stand. When the subject steps down from the stand, the InBody720 goes back to the Initial screen.

- (1) Do not leave the arms by your side. Form an angle of 15 degree between the arms and your side.
- (2) Stand comfortably during the testing. Do not flex your muscles.

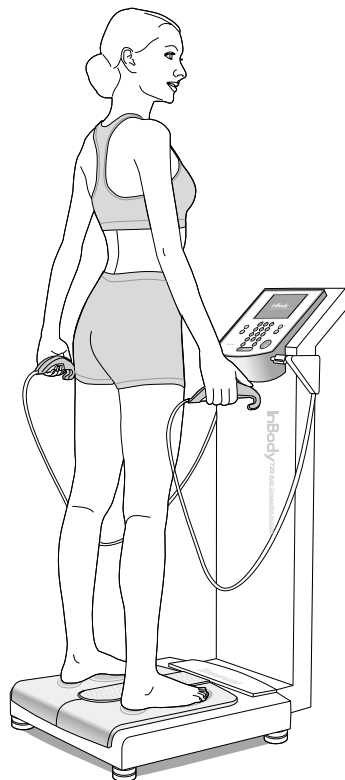

Disabled people who find standing for minutes a little bit difficult can get support from the back or side. In this case, there should be no skin-to-skin contact between the supporter and the subject. Testing is impossible with an amputee who has a thumb, an arm or a leg amputated.

7. How to Operate the Equipment

This procedure begins with the Initial screen, which is the initial environment settings of the InBody720, when it is factory-released. The InBody720 goes back to the Initial screen, as the subject steps down from the stand.

- (1) See if the InBody720 is in test-ready status. The windows that are in test-ready status should look like as shown below.

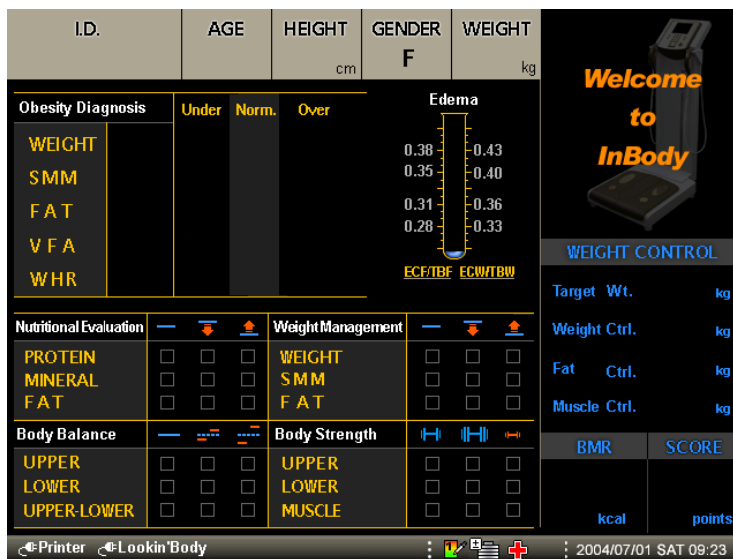

- (2) The less clothes or devices you wear during the test, the more accurate the test results will be. To get as close to the pure weight as possible, take off a heavy winter coat or wristwatch before testing.
- (3) Both heel and the ball of your feet should touch the foot electrode. Step on the stand in barefoot. Once you are on, the LCD monitor will display your weight. Put your hands down naturally and stand still comfortably, until the fluctuation in the weight goes down to zero and the value for weight is stabilized.
- (4) When the value for weight is stabilized, InBody720 displays the weight. The weight is recorded to the weight field of personal information windows, as the information windows switch to the personal information windows, prompting the user to enter personal information.



- (5) Enter the subject's personal information including I.D., height, and gender using the keypad buttons. After finishing the data entry, press the 'Enter' button and see the information windows prompting the subject to get ready for a test.

I.D.	AGE	HEIGHT	GENDER	WEIGHT
MISUK HAN	39	159 cm	F	65.9 kg

- (6) Follow the test instructions displayed on the information windows. InBody720 checks your posture on the equipment continuously. If the subject is settled on the stand, and his/her posture is right, the testing commences on its own. Once the test is underway, the subject should keep the same posture until the end of the test.

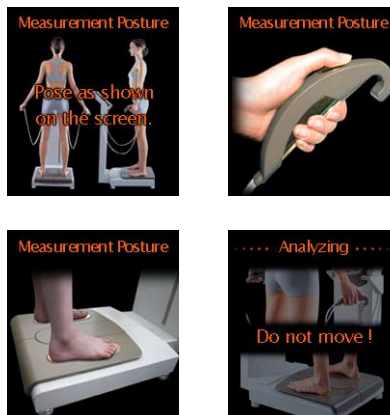

NOTE

If the subject doesn't take upon the right position, hold the hand electrode or step on the foot electrode properly or if the subject's palms or soles are dry or have too much dead and hard skin, the testing process may not initiate on its own. In this case, wipe up the subject's palm or feet with the electrolyte tissues that come with the InBody720 and put the subject back on the testing stand.



NOTE

If a data entered is out of the permissible data range, the following message will pop up on the monitor. Go back to the test field where you were and re-enter data. Refer to the "5. Personal Profile" of this chapter for the permissible range of each data.



NOTE

If the subject's palms or soles are dry, the following message will be shown on the information windows and the test stops. In this case, wipe up the subject's palms or soles with the electrolyte tissues that come with the InBody720 and re-initiate the test process.



- (7) During the analysis result windows on the LCD monitor will display the results of body composition analysis in the order of the test procedure.

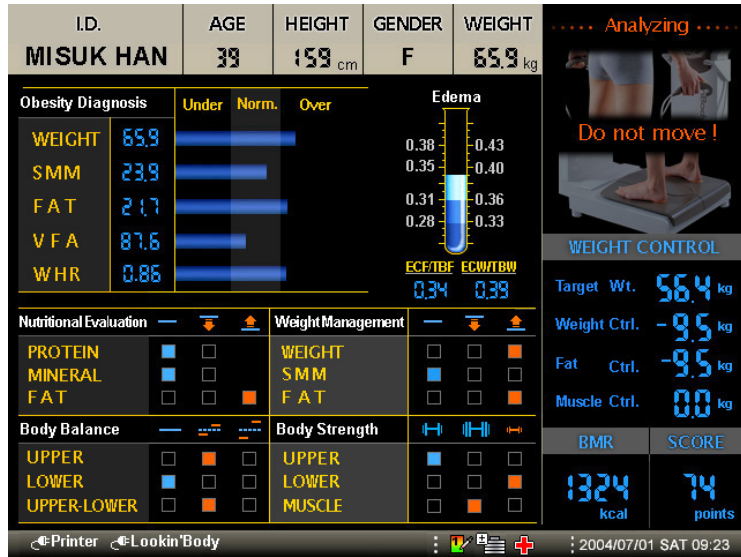

Analysis results window

- (8) When the analysis is completed, the InBody720 informs that the test is completed through the information windows.



- (9) The subject should place the hand electrode back to where it was, and step down from the stand.



NOTE Do not drop the hand electrode, as it contains electronic parts inside.

- (10) Soon after the subject steps down from the equipment, the InBody720 prints out test results sheet and goes back to the Initial screen. For information, refer to the “8. Results” of this chapter.



NOTE InBody720 is equipped with archive function, allowing the user to print out the past 10 test results per each subject.

8. Results

A. Analysis result window

During the test, information on body composition analysis is displayed on Analysis result window on the LCD monitor. As long as the subject is on the stand, the monitor retains the data of the body composition analysis. Once the subject steps down, the InBody720 goes back to the initial screen and sets itself back to test-ready status.

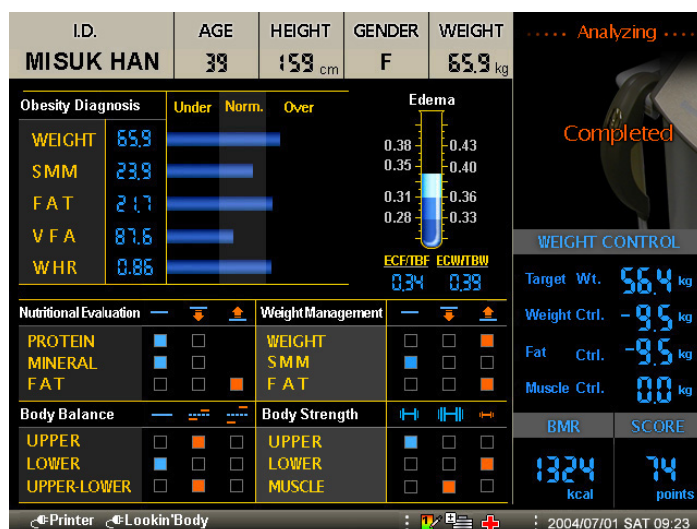

(1) Output items

The InBody720 provides the following information through the analysis result window.

- ① Obesity Diagnosis
- ② Edema
- ③ Nutritional Evaluation
- ④ Weight Management
- ⑤ Body Balance
- ⑥ Body Strength
- ⑦ Weight Control
- ⑧ BMR
- ⑨ Fitness score

(2) Various comprehensive evaluation

The analysis result window of InBody720 summarizes all the obtained results. This makes much easier for subjects to comprehend their health condition. Using different marks, it even distinguishes the poor and the fine conditions. It helps to check and see overall body composition at a glance.

Each mark has the following meaning.

① Nutritional Evaluation

—: Normal ↓: Deficient ↑: Excessive

② Weight Management

—: Normal ↓: Under ↑: Over

③ Body Balance

—: Balanced - - - : Slightly Unbalanced - - - - : Extremely Unbalanced

④ Body Strength

||: Normal ||||: Developed |||: Weak

B. Result sheet for adult

With a printer connected to the InBody720, the InBody720 can print out the results sheet, providing the details on test results.

(1) Connecting to the printer

Use a printer that connects to 25pin parallel port (IEEE1284) or USB1.1 port. InBody720 can use any printer that supports PCL3 interface or higher version. For details on printer, refer to the "Chapter 5 Consumables." As for the installation of a printer, consult the user's manual provided by the printer manufacturer.

(2) Result sheet Form

The results sheet is shown below. It is one of the consumable products provided by InBody.

InBody

720 Body Composition Analysis

I.D.	AGE	HEIGHT	GENDER	DATE / TIME
25	36	170.9cm	Male	2009.11.03 18:43:45(310)

B. Hospital
Doctor Lee

Body Composition Analysis

Compartments	Values	Total Body Water	Soft Lean Mass	Fat Free Mass	Weight	Normal Range
I C W Intracellular Water (ℓ)	24.8	39.3	50.7	53.7	71.7	22.4 ~ 27.4
E C W Extracellular Water (ℓ)	14.5					13.8 ~ 16.8
Protein (kg)	10.7					9.7 ~ 11.9
Mineral (kg)	3.63	OSSEOUS: 2.98				3.34 ~ 4.08
Body Fat Mass (kg)	18.0					7.7 ~ 15.4

▶ Mineral is estimated.

Muscle - Fat Analysis

	Under	Normal	Over	UNIT	Normal Range
Weight (kg)	55	70	100	71.7	54.7 ~ 73.9
S M M Skeletal Muscle Mass (kg)	70	80	100	30.3	27.5 ~ 33.5
Body Fat Mass (kg)	40	60	80	18.0	7.7 ~ 15.4

Obesity Diagnosis

	Under	Normal	Over	Normal Range	
B M I Body Mass Index (kg/m ²)	10	15	25	24.5	18.5 ~ 25.0
P B F Percent Body Fat (%)	0	5	15	25.1	10.0 ~ 20.0
W H R Waist-Hip Ratio	0.70	0.75	0.85	0.88	0.80 ~ 0.90

Visceral Fat Area

*79.3

Lean Balance

	Under	Normal	Over	UNIT	Segmental Edema	Edema
Right Arm (kg)	55	70	100	89.7	0.318	0.364
Left Arm (kg)	55	70	100	91.8	0.319	0.365
Trunk (kg)	70	80	100	95.0	0.323	0.370
Right Leg (kg)	70	80	100	97.8	0.322	0.368
Left Leg (kg)	70	80	100	98.1	0.327	0.373

▶ Segmental fat is estimated.

Body Composition History

DATE/TIME	Weight	SMM	Fat	Score	ECW/TBW
091021 14:40	71.4	30.7	17.1	72	0.372
091021 14:45	71.5	30.8	16.9	73	0.372
091021 19:03	71.8	30.9	17.2	73	0.371
091022 12:28	71.8	32.2	15.2	77	0.366
091022 12:47	71.8	32.0	15.5	76	0.368
091022 12:59	71.8	31.7	15.9	75	0.369
091022 13:08	71.7	32.1	15.4	76	0.367
091022 13:28	71.7	32.6	14.6	78	0.365
091103 18:22	71.7	30.7	17.5	72	0.369
091103 18:43	71.7	30.3	18.0	71	0.369

Additional Data (Normal Range)

Obesity Degree = 111% 90 ~ 110

BCM = 35.5 kg 32.1 ~ 39.2

BMC = 2.98 kg 2.75 ~ 3.37

BMR = 1529 kcal 1554 ~ 1818

A C = 32.6 cm

AMC = 26.5 cm

Weight Control

Target Weight	64.2 kg
Weight Control	- 7.5 kg
Fat Control	- 8.4 kg
Muscle Control	+ 0.9 kg
Fitness Score	71 Points

Impedance

Z	RA	LA	TR	RL	LL
1kHz	389.6	385.4	31.1	300.7	295.4
5kHz	384.4	375.1	29.7	293.5	288.2
50kHz	332.4	323.9	24.9	250.7	247.3
250kHz	292.3	284.8	20.8	222.9	221.3
500kHz	279.0	273.5	19.5	216.1	215.1
1MHz	268.3	264.1	18.3	211.1	210.1

Output items

This section includes the definitions, description and clinical standard of each category of test results. If you need more explanation or clarification on this manual, email or phone to us at:

E-mail: info@inbody.com TEL: +82-2-501-3939

(1) Individual Information

The subject's I.D., age, height, gender and exam date and time are displayed here.

(2) User Information

The name of the hospital or clinic and the doctor in charge are displayed here.

I.D.	AGE	HEIGHT	GENDER	DATE / TIME	B. Hospital Doctor Lee
25	36	170.9cm	Male	2009.11.03 18:43:45(310)	

* Please contact InBody Co., Ltd. or sales division if you need to enter or correct "User Information"

(3) Body Composition Analysis(9 items)

Body Composition Analysis						
Compartments	Values	Total Body Water	Soft Lean Mass	Fat Free Mass	Weight	Normal Range
I C W (ℓ) <small>Intracellular Water</small>	24.8	39.3	50.7	53.7	71.7	22.4 ~ 27.4
E C W (ℓ) <small>Extracellular Water</small>	14.5					13.8 ~ 16.8
Protein (kg)	10.7					9.7 ~ 11.9
Mineral (kg)	3.63	<small>non-osseous</small> osseous: 2.98				3.34 ~ 4.08
Body Fat Mass (kg)	18.0					7.7 ~ 15.4

▶ Mineral is estimated.

The body composition analysis of InBody720 is derived from the 4-compartment model, which divides body composition into 4 components comprising Total Body Water, Protein, Mineral and Body Fat. Your own data are displayed here. Total body weight is the sum of Body Fat and Fat Free Mass (FFM). FFM is the sum of Mineral and Soft Lean Mass (SLM). SLM is the sum of Protein and Total Body Water consisting of Intracellular Water (ICW) and Extracellular Water (ECW), which are separated by cell membranes. 'Normal Range' means standard value range when your body has ideal body composition for your own height.

- ① Intracellular Water (ℓ) : The water inside each cell
- ② Extracellular Water (ℓ) : The water outside each cell
- ③ Protein Mass (kg)
- ④ Mineral Mass (kg)

Mineral Mass cannot be obtained with BIA methodology, but InBody 720 offers the estimated value of Mineral Mass because Bone Mineral Mass is closely correlated with FFM. The correctness of this estimated value has been validated by comparison with the DEXA method. Thus, Mineral mass could be used for screening the subjects who have risk factors of osteoporosis.

- ⑤ Body Fat Mass (kg)

6 Total Body Water (ℓ)

The sum of the intracellular and the extracellular water.

**It is shown as “ℓ” on the results sheet. However, mass measured in kilograms (kg) is the basic unit of measure for body composition components. Therefore, the unit volume of water should be converted to a mass unit. It is a common known fact that the volume of 1 liter(ℓ) is equal to the mass of 1kg in water. This fact allows volume and mass to be interchangeable i.e. used at the same time.*

7 Soft Lean Mass (kg)

The ideal weight is calculated based on subject’s height. A subject’s soft lean mass can be estimated using average weight and average percent body fat. Problems occur only when the soft lean mass is less than the average, however, no difficulties are encountered when soft lean mass is greater than average.

8 Fat Free Mass (kg)

The sum of soft lean mass and the mineral mass.

9 Weight (kg)

Ideal weight is based on subject’s height. The basic unit of measure for water is volume.

(4) Muscle-Fat Analysis(3 items)

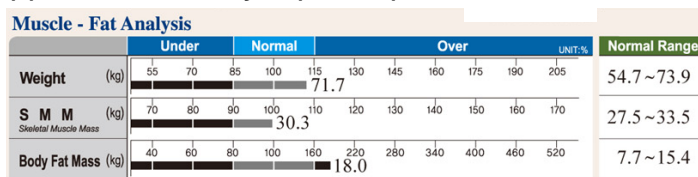

Bar graphs and values are displayed here. The length of the bar graph is the relative percentage based on the standard amount (100%). The values at the end of each bar are the measured values. Especially, because body fat is more various among people than muscle mass, each bar has different scale. The value next to bar shows you the measured values and the end of bar indicates your position in the range. If the length of the bars would be similar, your body composition is well balanced, while if the lengths of the bars fluctuate, it means your body composition is not balanced.

1 Weight (kg)

Generally, BMI 18.5~25 is used for determining normal range of weight. But in InBody 720, normal range for Weight is standard weight $\pm 15\%$ of standard value, and the range is very similar to the one based on BMI (18.5~25). Standard weight is determined according to BMI 22 for males, BMI 21 for asian females, BMI 21.5 for western females, and growth chart for the age under 18.

2 Skeletal Muscle Mass (kg)

Skeletal muscle mass is computed based on muscle mass of the limbs, which is almost composed of skeletal muscle and takes up about 70% of total body skeletal muscle.

3 Body Fat Mass (kg)

100% of the body fat mass means the subject is in the ideal weight and the normal percent body fat. Compared with muscle mass, body fat mass is various among people. The horizontal bar graph helps you understand your body composition state compared to standard values. Especially, because body fat is more various among people than muscle mass, those two bars have different scale.

(5) Obesity Diagnosis

Obesity Diagnosis offers indexes for the diagnosis of the extent of obesity.

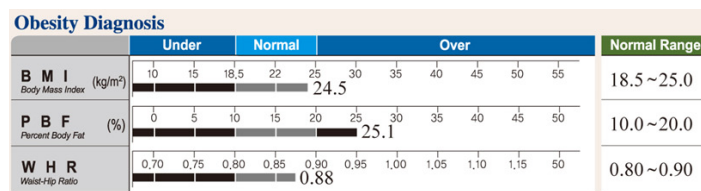

① BMI (Body Mass Index, kg/m²)

BMI is determined by using only weight and height and diagnoses superficial obesity.

The standard values are 22kg/m² for male and 21.5kg/m² for western female and 21kg/m² for Asian female.

$$\text{Formula) BMI} = \text{weight (kg)} \times \text{height}^2 \text{ (m}^2\text{)}$$

Determination 1) WHO Standard

BMI(kg/m ²)	Classification	Diagnosis
<18.5	Underweight	Under Infectious disease, malnutrition related disease
18.5~24.9	Normal	Standard Least risk at most disease
25.0~29.9	Overweight	Over May cause health problem
30.0~34.9	Obese1	Increase of the risk of cardiac disease, high blood pressure, diabetes, etc.
35.0~39.9	Obese2	
≥40	Severely Obese	

Ref. WHO and the National Heart, Lung, and Blood Institute : clinical guidelines on the identification, evaluation, and treatment of over weight and obesity in adults, the evidence report. June 1998, xiv

Determination 2) Asian-Pacific Standard

BMI(kg/m ²)	Classification	Risk of associated disease
<18.5	Underweight	Low (high risk of other clinical disease)
18.5~22.9	Normal	Average
>23	Overweight	Increased
23~24.9	Risky Overweight	
25.0~29.9	Obese step1	Moderate
>30	Obese step2	Severe

Ref. Korean Society for the Study of Obesity, chapter 2. Redefining and Evaluation, The Asian-Pacific perspective : Redefining Obesity and its Treatment., 1st edition, Korean Society for the Study of Obesity, 2001, p10.

*For children under the age of 18, children's standard is used.

② Percent Body Fat (%)

Percent Body Fat indicates the percentage of Body Fat to body weight. The standard Percent Body Fat is 15% for men and 23% for women, while the standard range of Body Fat Mass for men is 10-20% of the standard weight, and 18-28% of the standard weight for women. In the case of children under the age of 18, children's standard is used.

Ref. Samuel J. Fomon, et al. (1982): Body Composition of reference children from birth to age 10 years. The American Journal of Clinical Nutrition 35, 1169-1175.

3 Waist-Hip Ratio

Waist-Hip Ratio (WHR) is obtained from dividing your waist size by your hip size and it is used for looking at the proportion of fat stored on your body around your waist and hip. The normal range of WHR is 0.80~0.90 for male and 0.75~0.85 for female. Your WHR is an important tool that helps you determine your overall health risk. InBody analyzes body composition with no empirical factor such as gender and age. However, WHR offered from InBody is the data affected by empirical factors. So to speak, InBody estimates body size from distributing total body fat to each segment considering empirical factors and muscle distribution calculated by segmental impedances.

(6) Lean Balance (5 items)

Graphs for segmental lean body mass is presented as two horizontal bars for each segment.

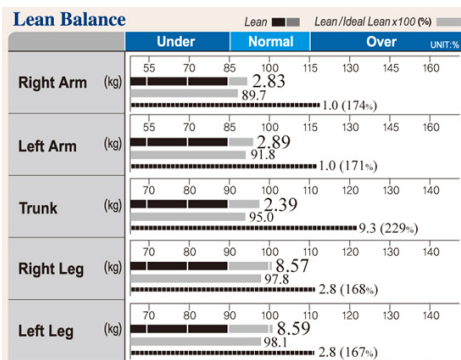

Of the two bar graphs, the number next to the above bar (■) represents the absolute value for lean body mass of an subject in kilograms. In the range, 100% actually determines the length of the graph. It represents ideal lean body mass in the ideal weight of the subject to his or her height. This does not take the actual weight of the subject into account. The number next to the below bar (■) represents the ratio of actual lean body mass of the

subject to ideal lean body mass in his or her weight and its unit is percentage. In the range, 100% again determines the length of the graph. However, it represents ideal lean body mass in the actual weight of the subject.

- 1 Right Arm (kg) : The value shows the amount of muscles in right arm.
- 2 Left Arm (kg) : The value shows the amount of muscles in left arm.
- 3 Trunk (kg) : The value shows the amount of muscles in trunk.
- 4 Right Leg (kg) : The value shows the amount of muscles in right leg.
- 5 Left Leg (kg) : The value shows the amount of muscles in left leg.

**Because the upper fat free mass(U-FFM) has a wide range of variation among people compared to lower fat free mass(L-FFM), the standard range of U-FFM is wider than that of L-FFM.*

(7) EDEMA

Segmental Edema		Edema	
ECF/TBF	ECW/TBW	ECF/TBF	ECW/TBW
0.318	0.364		
0.319	0.365	0.41	0.46
0.323	0.370	0.35	0.43
0.322	0.368	0.33	0.38
0.327	0.373	0.28	0.33
		0.25	0.30
		0.323	0.369

EDEMA means an excessive accumulation of serous fluid in tissue spaces, which results in swelling. This graph shows the ratio of ECW to TBW and ECF to TBF. The normal range of this score is 0.36 ~ 0.39 and 0.31 ~ 0.34 respectively, which is maintained in a healthy person. Usually, edema score increases when the ECW expands. In case of aging and malnutrition subject, the muscle cell shrinks, and the interstitial space gets filled up with water. As a result, ECW increases.

InBody720 also shows segmental edema score as well as total edema score.

(8) Visceral Fat Area

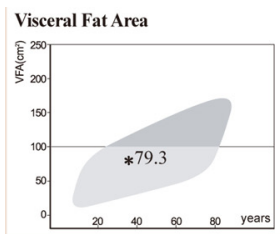

VFA(Visceral Fat Area) is the cross sectional visceral fat area obtained from the CT(Computed Tomography) view of the abdominal region.

Normal : <100cm²

Over : 100~150cm²

Extremely over : >150cm²

(9) Various comprehensive evaluation(6 items)

Nutritional Evaluation

Protein Normal Deficient

Mineral Normal Deficient

Fat Normal Deficient Excessive

Weight Management

Weight Normal Under Over

SMM Normal Strong Under Over

Fat Normal Under Over

Obesity Diagnosis

BMI Normal Under Over Extremely Over

PBF Normal Over Extremely Over

WHR Normal Over Extremely Over

Body Balance

Upper Balanced Slightly Unbalanced Extremely Unbalanced

Lower Balanced Slightly Unbalanced Extremely Unbalanced

Upper-Lower balanced Slightly Unbalanced Extremely Unbalanced

Body Strength

Upper Normal Developed Weak

Lower Normal Developed Weak

Muscle Normal Muscular Weak

Health Diagnosis

Body Water Normal Under

Edema Normal Slight Edema Edema

Life Pattern Normal Alert Risky Highly Risky

The result sheet of InBody720 summarizes all the obtained results on the right side. This makes much easier for subjects to comprehend their health condition. Using different colors, it even distinguishes the poor and the fine conditions. It helps to check and see overall body composition at a glance.

- 1 Nutritional Evaluation
- 2 Weight Management
- 3 Obesity Diagnosis
- 4 Body Balance
- 5 Body Strength
- 6 Health Diagnosis

(10) Weight Control(4 items)

Weight Control	
Target Weight	64,2 kg
Weight Control	- 7,5 kg
Fat Control	- 8,4 kg
Muscle Control	+ 0,9 kg

InBody720 calculates a Target Weight. This is not merely showing an ideal weight. Instead, the calculation of the target weight is based on the complete evaluation of the body composition

diagnosis. Apart from the fact that the conventional standard weight is a height specific, and population-based statistical information, Target Weight is personalized information based on InBody720 measurement. It tells how to control the weight especially by gaining or losing muscle or fat. The (+) and (-) sign indicate an increase or decrease in the amount to be controlled. The fitness score is to help the subject to understand his/her body condition from a body composition point of view. The ideal is 100%. It is a piece of unique data provided by InBody720.

① Target Weight (kg)

It is the result of the calculation of the amount of the optimal muscle mass. It is also based on the consideration of the other body components that the control value should be reasonable to the subject's body composition.

② Weight Control(kg)

The sum of the fat and the muscle to be controlled.

③ Fat Control(kg)

The amount of fat to be increased or decreased.

④ Muscle Control(kg)

The amount of muscle to be controlled.(kg)

(11) Fitness Score

Fitness Score | Points

The Fitness Score is an arbitrary score based on the measured muscle and fat mass for the motivation of the subjects.

Under 70 : Weak Type

70~90 : Normal Type

Over 90 : Athletic Type

(12) Body Composition History

Body Composition History						
DATA/TIME	Weight	SMM	Fat	Score	ECW/TBW	
09/10/21 14:40	71.4	30.7	17.1	72	0.372	
09/10/21 14:45	71.5	30.8	16.9	73	0.372	
09/10/21 19:03	71.8	30.9	17.2	73	0.371	
09/10/22 12:28	71.8	32.2	15.2	77	0.366	
09/10/22 12:47	71.8	32.0	15.5	76	0.368	
09/10/22 12:59	71.8	31.7	15.9	75	0.369	
09/10/22 13:08	71.7	32.1	15.4	76	0.367	
09/10/22 13:28	71.7	32.6	14.6	78	0.365	
09/11/03 18:22	71.7	30.7	17.5	72	0.369	
09/11/03 18:43	71.7	30.3	18.0	71	0.369	

The balance of muscle and fat mass is very important in weight controlling. And, exercise is necessary for maintaining muscle mass. Thus, monitoring your skeletal muscle mass, body fat mass, EDEMA and Fitness score will help you achieve your healthy weight control.

(13) Additional Data(6 items)

Additional Data	(Normal Range)
Obesity Degree = 111%	90 ~ 110
BCM = 35.5 kg	32.1 ~ 39.2
BMC = 2.98 kg	2.75 ~ 3.37
BMR = 1529 kcal	1554 ~ 1818
A C = 32.6 cm	
AMC = 26.5 cm	

This section shows you commonly used data, related to body composition.

1 Obesity Degree(%)

Obesity Degree, measured in percentage, is a convenient way of assessing the subject's degree of obesity but body composition is not considered. Obesity degree is calculated using only a subject's weight.

$$\text{Obesity Degree} = (\text{actual weight} / \text{standard weight}) \times 100$$

2 Body Cell Mass(kg)

Body Cell Mass (BCM) reflects all the metabolically active tissues of the body. Decreasing BCM is an indicator for malnutrition. For the HIV subject, BCM is very important to monitor the Wasting Syndrome. Only with body composition analysis can this be monitored. It include the total mass of cells, which compose muscular tissues.

3 Bone Mineral Content(kg)

Bone Mineral Content(BMC) is mineral mass in bone.

4 Basal Metabolic Rate (kcal)

Basal Metabolic Rate (BMR) is the minimal energy requirement for sustaining vital functions at rest. With InBody720, BMR is estimated by a known regression equation based on FFM. FFM is known to be closely related to BMR.

5 AC(Arm Circumference)

It is the circumference of upper arm measured in the middle of the elbow and the shoulder.

6 AMC(Arm Muscle Circumference)

Arm Muscle Circumference is the muscle circumference of the arm inside the subcutaneous fat. It is measured horizontally around the arm at the mid-point of the between the acromion process and the olecranon process.

(14) Bioelectrical Impedance

Impedance

Z	RA	LA	TR	RL	LL
1kHz: 389.6	385.4	31.1	300.7	295.4	
5kHz: 384.4	375.1	29.7	293.5	288.2	
50kHz: 332.4	323.9	24.9	250.7	247.3	
250kHz: 292.3	284.8	20.8	222.9	221.3	
500kHz: 279.0	273.5	19.5	216.1	215.1	
1Mhz: 268.3	264.1	18.3	211.1	210.1	

It shows the impedance values from the measurements at 6 frequencies (1, 5, 50, 250, 500, 1000kHz). For further research purpose, from the left to the right, it shows the values for the right arm, left arm, trunk, right leg and left leg. These data indicate if the measurement is successful or not. The data should decrease vertically. Otherwise, the measurement is wrong or the unit is defective.

C. Result sheet for a child

If you choose to print out a report for child at the setup (please refer to 3-4p for setup), below result sheet comes out.

InBody
[InBody 720]

ID	Age	Height	Weight	Gender	Date/Time
1028	12	151cm	50.2kg	F	2010.01.28/14:22

B. Hospital
Doctor Lee

What's my growth score? 70 Points

Let's discover what my body is made up of

Occupying most of my body	Body Water	22.9 kg	Nutrition Evaluation	Protein	<input type="checkbox"/> Enough <input checked="" type="checkbox"/> Too little
Making muscle	Protein	6.1 kg		Mineral	<input checked="" type="checkbox"/> Enough <input type="checkbox"/> Too little
Making bones strong	Mineral	2.30 kg		Body Fat	<input type="checkbox"/> Enough <input checked="" type="checkbox"/> Too much
Storing extra energy	Body Fat	18.9 kg			

Shall we check if my body is well balanced?

My total Weight	25 40 55 70 85 100 115 130 145 160 175 190	UNIT %
For a great body shape	Muscle	95 85 75 65 55 45 35 25 15 5
Am I eating too much?	Body Fat	4 30 40 50 60 70 80 90 100 200 300 400 450
		Under Normal Over

Connect the end of the graphs to see what shape it makes—a 'D' shape is great.

Is my body growing well?

Left Right

How to look at the body shape graph

Upper body developed / Lower body undeveloped

Upper body undeveloped / Lower body developed

How to understand the body shape square range

too little

enough

standard

very good

Let's have a look at the size and shape of the square. The bigger and more square the shape, the better, meaning your muscle is well developed.

My height and weight compared to my friends

height

weight

If the height and weight are at the 50% mark then you are right in the middle state of growth compared to other children. If under 10% or over 90%, special care can be required.

Evaluation of my body

Ideal to my body composition	Weight	45.1 kg	BMI	22.0 kg/m ²	<input checked="" type="checkbox"/> normal <input type="checkbox"/> over
You need to change	Weight	- 5.1 kg	PBF	37.6 %	<input type="checkbox"/> normal <input checked="" type="checkbox"/> slightly over
You need to change	Muscle Mass	+ 4.3 kg	OD	110 %	<input type="checkbox"/> normal <input checked="" type="checkbox"/> over weight
You need to change	Body Fat	- 9.4 kg	BMR	1047 Kcal	<input type="checkbox"/> normal <input checked="" type="checkbox"/> under

note WHR : 0.81

Impedance Z	RA	LA	TR	BL	LL
	524.3	531.5	33.5	308.8	313.3
500Hz	524.6	535.4	33.9	309.5	308.4
	471.2	488.3	29.9	272.9	276.2
2500Hz	436.3	439.8	25.6	245.5	249.1
	414.3	421.8	23.8	239.4	243.3
1MHz	398.3	401.5	21.8	237.1	242.4

Copyright © 1998-2008 by Biospace Co., Ltd. All rights reserved. BPO-003-001-0022

Output items

This section includes the definitions, description and clinical standard of each category of test results. If you need more explanation or clarification on this manual, email or phone to us at:

E-mail: info@inbody.com TEL: +82-2-501-3939

(1) Individual Information

The subject's I.D., age, height, weight, gender and exam date and time are displayed here.

(2) User Information

The name of the hospital or clinic and the doctor in charge are displayed here.

ID	Age	Height	Weight	Gender	Date/Time	[InBody720]	B. Hospital
1028	12	151cm	50.2kg	F	2010. 01. 28/14:22		Doctor Lee

* Please contact InBody Co., Ltd. or sales division if you need to enter or correct "User Information".

(3) Let's discover what my body is made up of.

		Let's discover what my body is made up of			
Occupying most of my body	Body Water	22.9 kg	Nutrition Evaluation	Protein	<input type="checkbox"/> Enough <input checked="" type="checkbox"/> Too little
Making muscle	Protein	6.1 kg		Mineral	<input checked="" type="checkbox"/> Enough <input type="checkbox"/> Too little
Making bones strong	Mineral	2.30 kg		Body Fat	<input type="checkbox"/> Enough <input type="checkbox"/> Too little
Storing extra energy	Body Fat	18.9 kg			<input checked="" type="checkbox"/> Too much

This part provides qualitative values of the body composition. Alongside the measured values of each body composition, there is nutrition evaluation from the measured values to help children understand. It would be good to explain what roles proteins, minerals, fattiness play in our body and what problems might occur when these are lacking or too abundant.

1 Body Water (kg)

It covers the largest portion among body composition accounting for about 50~70% of body weight. It is distributed in the cells and body fluids. If we look into our body from composition point of view, it is like a systemized sea water bag. Body water is mostly distributed at the cells which compose the muscle tissue and over 70% of water fills healthy person's muscle while minerals and body fat do very little.

2 Protein (kg)

Protein is a complex of organic compounds with nitrogen and it indicates the total amount of solid components. Protein has very close relationship with intracellular fluid and the lack of protein means the nutritional imbalance. However this does not mean the protein in food. If there is a severe shortage in protein mass, it can bring symptoms such as loss of nails and toenails, amenorrhea, hair discoloring, muscle atrophy, fatty liver, edema, etc.. Human body consumes body composing proteins when there is shortage in energy provision in body. This is an undesirable energy generation process and if excessive rates of such process continue for a long time of period, it could burden liver, kidney and others. For growing children, protein is an essential component in particular.

During a growth period various parts of our body are developed especially skeletal structure and muscle mass. Therefore, it is necessary to have sufficient amount of protein during a growth period since major components of muscle is the protein.

3 Mineral (kg)

Minerals help the body preserve and play a core role in the human body. InBody analyzes two large groups of minerals: osseous minerals and non-osseous minerals. Osseous minerals are the minerals found in the bones while non-osseous minerals are those which are found in all other parts of the body. Osseous minerals account for about 80% of the body's total minerals. The quantity of minerals found in the body is closely related to the muscle mass. As muscle mass increases, the weight of bones also increases.

During a growth period when there is a dramatic growth in bones, it is necessary to have good mineral mass to ensure the smooth development of a skeleton structure.

4 Body Fat (kg)

Fat free mass is the sum of body water, protein and mineral. Thus, InBody uses the following formula to get the amount of body fat mass.

$$\text{Body Fat Mass} = \text{Body Weight} - \text{Fat Free Mass (FFM)}$$

The sum of body water, protein mass, mineral mass, and body fat mass, which explained so far constitutes the weight.

Body Fat Mass is stored under the skin, as well as between the abdomen and muscles. When an subject's body fat mass is outside of the standard range, he/she is diagnosed as being obese.

(4) Shall we check if my body is well balanced?

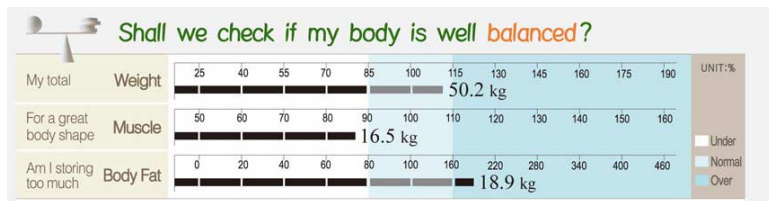

This part shows the measured values of three weight, skeletal muscle mass, and body fat mass, and their relative comparison in figures and in bar graphs. The figures next to the bar graphs indicate the measured values of each composition while the length of the graphs does the percentages against ideal values for each. One hundred percentage of the normal range refers the ideal values of each composition based on subject's ideal weight. Thus it is easy to recognize the balance of body components through the relative lengths of bar graphs against the 100% ideal values.

① Weight (kg)

100% ideal weight indicates the ideal value for the subject's height. Ideal weight is obtained from BMI ideal weight calculation.

Ideal weight (kg) = Ideal BMI (kg/m²) the square of the height in meters (m²)

Ideal BMI follows young children's BMI by height and gender.

② Skeletal Muscle Mass (kg)

Muscle in this part refers to the skeletal muscles attached to the bones. 100% ideal skeletal muscle mass indicates the ideal amount of skeletal muscle mass that one should have when the subject has an ideal weight.

In particular, as bone development actively progresses during a growth period, it is necessary to have a well-developed skeletal muscle mass to supports smooth growth of bones.

③ Body Fat Mass (kg)

100% ideal body fat mass is the amount of body fat mass one should have when one has an ideal weight. The bar graph shows the percentage of the current body fat mass divided by ideal body fat mass to display the degree of appropriate amount of body fat.

Ideal body fat mass is what one should have when one has an ideal weight.

(5) Is my body growing well?

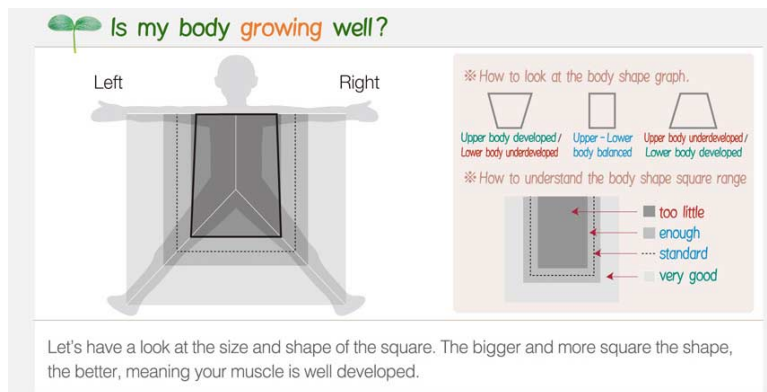

In the body model, we look at how the shape of square is and where the each vertex falls in. The shape of square allows the evaluation of an individual body parts such as upper and lower balance, and left and right balance. Also using the range in which each vertex belongs, we can see the muscle development in limbs.

(6) My height and weight compared to my friends.

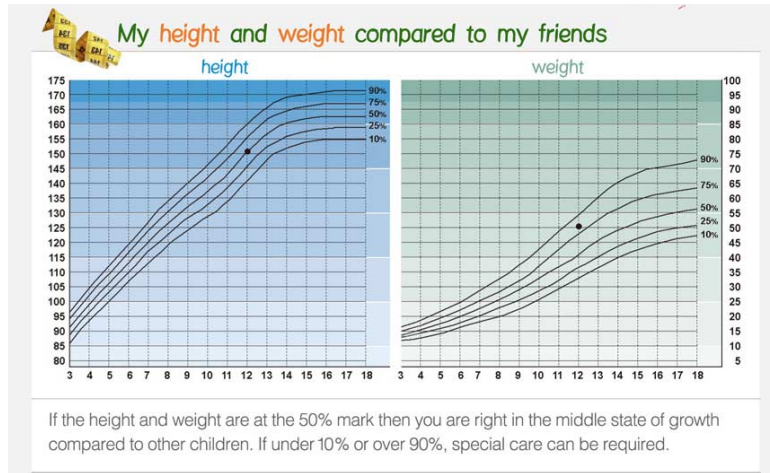

This part is to check a subject's developmental status through a percentile graph that enlarges a growth curve according to his/her age and gender. Percentile is a score that shows one's relative position in the distribution of the group to which he/she belongs. The 50th percentile (50%) indicates a mean value, and if it is closer to the 50th percentile, it means one's growth is at a rate close to the middle. However, there is no need for worry if one falls between the 10th percentile (10%) and the 90th percentile (90%), rather than the 50th percentile. But if one is lower than the 10th percentile (10%) or higher than the 90th percentile (90%), careful attention is required for the child's growth.

(7) Evaluation of my body

Evaluation of my body					
Ideal to my body composition	Weight	45.1 kg	BMI Body Mass Index	22.0 kg/m ²	<input checked="" type="checkbox"/> normal <input type="checkbox"/> under <input type="checkbox"/> over <input type="checkbox"/> very over
You need to change	Weight	- 5.1 kg	PBF Percentage Body Fat	37.6 %	<input type="checkbox"/> normal <input type="checkbox"/> under <input type="checkbox"/> slightly over <input checked="" type="checkbox"/> very over
You need to change	Muscle Mass	+ 4.3 kg	OD Obesity Degree	110 %	<input type="checkbox"/> normal <input type="checkbox"/> weak <input checked="" type="checkbox"/> over weight <input type="checkbox"/> very over
You need to change	Body Fat	- 9.4 kg	BMR Basal Metabolic Rate	1047 Kcal	<input type="checkbox"/> normal <input checked="" type="checkbox"/> under <input type="checkbox"/> over

1 Weight Control

For growing children, it is not a good idea to blindly lose weight to achieve an ideal weight. It would be advisable to maintain ideal body components while monitoring muscle mass and the amount of body fat.

2 BMI

The ideal BMI for children below 18 years old differ from each other by height and gender. The standard BMI range is within ± 3 of ideal BMI.

< Ideal BMI-3	under
Ideal BMI -3 ≤ ~ < Ideal BMI +3	normal
Ideal BMI +3 ≤ ~ < Ideal BMI +6	over
Ideal BMI +6 ≤	very over

3 Percentage Body Fat

Children below 18 years of age have different ideal body fat rates depending on their gender and weight. The standard range is within $\pm 5\%$ of ideal body fat rates. Slight overweight refers to a stage with a risk of overweight and is when one has larger than or same as $+5\%$ of an ideal body fat rates and smaller than $+10\%$ of an ideal body fat rates. Overweight is when body fat rate is larger than or equal to $+10\%$ of an ideal body fat rate.

4 Obesity Degree(%)

Obesity Degree(%)= (current weight/ standard weight by height) $\times 100$

Obesity index Degree is an index that determines obesity without considering individual body composition. The standard range stretches from above 90% and below 110%. Above 110% and below 130% is overweight and above 130% indicates obesity.

5 Basal Metabolic Rates (BMR)

Basal Metabolic Rate (BMR) is a value obtained by substituting the fat free mass of current test subject to a formula. The standard range stretches from above 90% and below 110%. Less than 90% indicates below standard and more than 110% is regarded as above the standard BMR. Ideal BMR is a value obtained by substituting the ideal fat free mass of a test subject to a formula.

(8) What's my growth score?

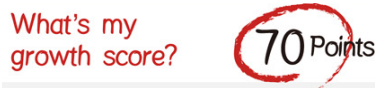

Growth score is a unique score of InBody that shows test results in recognizable scores so as to help understand the growth stage of children by taking into account physique and body components. It considers not only children's body composition but also obesity index degree, and physique such as height and weight.

Chapter 3 Setup Establishment

- 1. Setup Menu**
- 2. Quick Setup**
- 3. DATABASE**
- 4. Modification Example**

1. Setup Menu

Press the InBody720 Setup key to bring up the following windows.

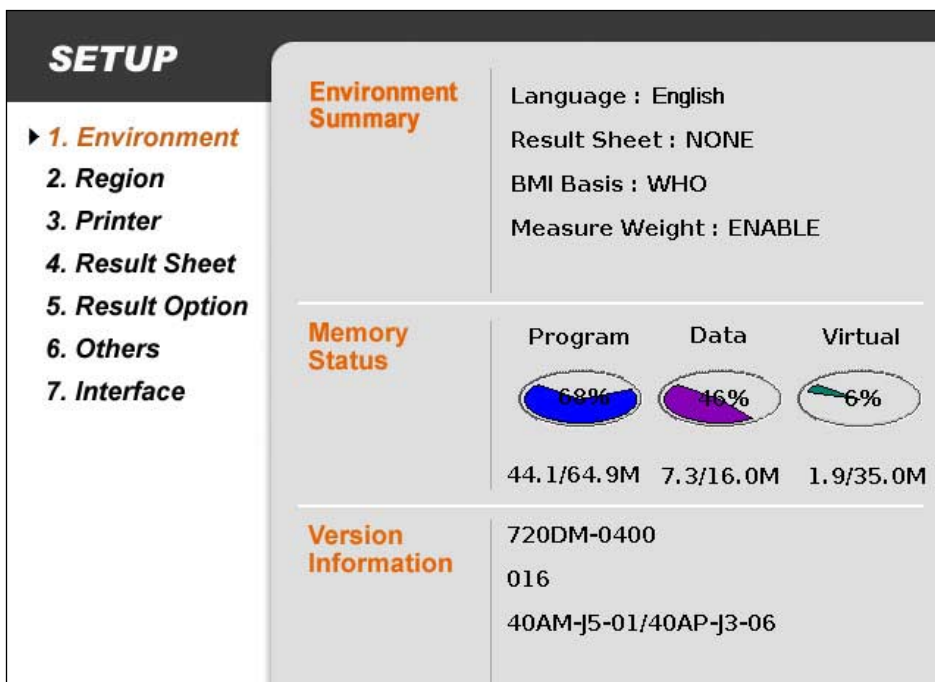

A. How to modify settings

- (1) Use the direction buttons (▲▼) to move and select one option of Environment, Region, Printer, Result Sheet, Result Option, Others and Interface.
- (2) Use the direction button (▶) at a particular setting to move to the sub-categories. Use the direction buttons(▲▼) to move into a sub-category of the setting you want to modify.
- (3) Each sub-category has a list of further sub-categories. Previously selected items will be displayed. Use the direction button(▶) to move to the category you want to select and modify using the direction buttons (▲▼).
- (4) If you have more categories to select, use the direction buttons(▲▼▶◀) again to move and select the category. If you are finished modifying the settings, move out to one of Environment, Region, Printer, Result Sheet, Result Option and Others using 'EXIT/MODE' button. Then press 'EXIT/MODE' button again.
- (5) When the screen asks whether or not you want to save modified contents, press ENTER or EXIT/MODE button to quit the setup menu.

B. Setup

(1) Environment

It shows the environmental status of the InBody720. No items can be changed by users.

Environment Summary

- ① Language : displays the current language.
- ② Result Sheet : displays the number of result sheet automatically printed after measurement.
- ③ BMI Basis : displays a selected standard range of BMI.
- ④ Measure Weight : displays the current selection of weight measurement.

Memory Status

- ① Program : shows capacity in use for program.
- ② Data : shows capacity in use for data storage.
- ③ Virtual : shows capacity in use for virtual memory.

Version Information : shows the current version of the InBody720.

(2) Region

Set the date, time, display mode, unit, ethnic background and language.

Set Date : Set the current date.

Set Time : Set the current time in the order of 'OO(hour)/OO(min)/OO(sec)

Display Mode : Select the date display mode. 'yy' is for year, 'mm' is for month and 'dd' is for date.

Unit : Select units to be used. (kg/cm, kg/in. , lb./cm, lb./in.)

Language : Select the language to be used.

Ethnic Background : Select the ethnic background of the subject.

(3) Printer

It is used to set a type of printer, adjust the printing alignment of result sheets and test print.

Printer

Select the type of printer. Printers that support PCL and SPL are compatible with the InBody720.

(Samsung PCL Printer, SPL Compatible Printer, HP PCL Printer, SPL 2009 Printer)

Alignment

It is possible to adjust the coordinates on the result sheet. After adjustment, you can check whether the alignment has done properly by 'test print'.(Adjustment range : +50~-50)

Test Print

You can check the printing coordinates by printing out a sample.

(4) Result Sheet

Mode

Select the type of result sheet.

- 1 Printed : to use printed result sheet provided by InBody.
- 2 Built-in : to use plain A4 paper. All formats of the result sheet will be printed out.

Number of Result Sheet Printing

You can decide the numbers of result sheet automatically printed after measurement. (0~2 sheets)



No result sheet is printed out when 'none' is selected.

Result Sheet

Select the basic result sheet to be printed out.

- 1 Default : InBody720 report is printed out.
- 2 For Child: In case of adult, the standard InBody720 report(default set result) is printed out and for child children's report comes out. The age to distinguish between adult and children can be set up by choosing the number next to 'For Child'. For instance, if you set up For Child (18), anyone less than 18 years old will have a report for a child, while those who are older than 18 years old will have an InBody720 report.

(5) Result Option

Set the standard range of BMI and result sheet printing mode.

BMI Basis

Select the standard range of BMI.

- 1 WHO : The standard range is 18.5~25 kg/m²
- 2 Asian : The standard range is 18.5~23kg/m²

Weight Control

This is an option of weight control provision on the results sheet.

- 1 Enable : Printout provision of weight control.
- 2 Disable : No printout provision of weight control.

Comprehensive Check

- 1 Enable : Printout comprehensive check.
- 2 Disable : No printout comprehensive check.

Mode

- ① Medical Purpose : The measurement duration is approximately 1minute, which is relatively short. Reactance value is not printed out.
- ② Research Purpose : The measurement duration is approximately 2 minutes. Reactance value is printed out.

Growth Chart

- ① WHO Basis: A type of a growth chart shown in a result sheet for child. It is a growth curve based on WHO.

(6) Others

Set up 'Measure Weight', 'Adjust Weight', 'Adjust Volume' and 'Initialize History'.

Measure Weight

- ① Enable : Weight is automatically measured and added to the personal information window.
- ② Disable : Directly enter the subject's weight in the personal information window.

Adjust Weight

Used to adjust weight offset value. When you want to adjust weight due to heavy clothes or accessories, set the offset value. It will be automatically applied to weight measurement.

(Adjustment Range : +5kg ~ -5kg, UNIT : 0.1kg)

Adjust Volume

Used to control sound volume. (0~100%)

Sound Type

Used to select sound type.

- ① Beep : Use Beep sound to inform measurement status.

Initialize History

Used to erase the entire history data.

Gender Default

Select the gender automatically added to the personal information window.
(Female, Male, Last Gender)

(7) Interface

Manual

DNS, Netmask, Gateway, IP, Host IP : Connect in the same way as connect general PC to the network.

Lookin' Body (PC)

- ① Ethernet Enable : to connect the InBody720 and PC by Lan cable.
- ② Serial Enable : to connect the InBody720 and PC by Serial cable.
- ③ Disable : Not use Lookin' Body.

Stadiometer

- ① Disable : Not use stadiometer.
- ② BSM230 (Ultrasonic)
- ③ BSM330 (Automatic)

Blood Pressure

- ① Disable : Not use blood pressure.
- ② TM2655/P
- ③ OMRON
- ④ KT
- ⑤ WELLTECH
- ⑥ 02RUN

2. Quick setup

User can modify the user environment easily. The changeable items are results sheet selection, weight adjustment and mode.

(1) How to modify the quick setup

- ① Press the EXIT / MODE button in the startup window.
- ② Select the item to change.
 - Use the “Left, Right direction button (◀ ▶)” to select the item.
 - Use the “Up, Down direction button (▲ ▼)” to adjust the item.

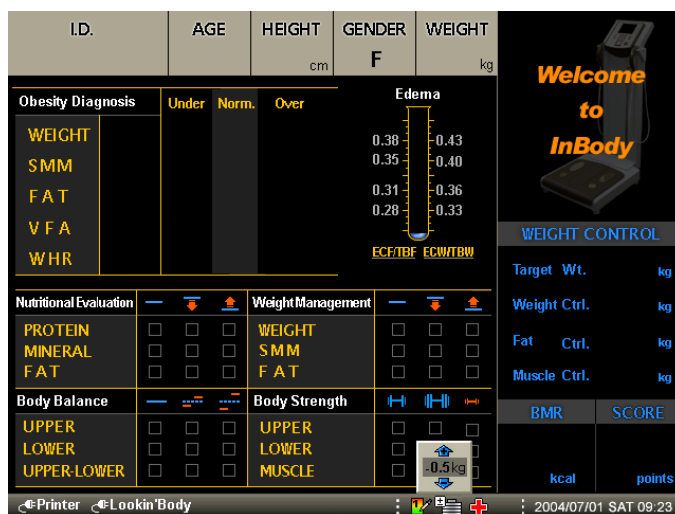

<In the case of 'weight adjustment' is selected >

- ③ The change is saved automatically. To go back to the initial screen, press the ENTER button or EXIT/MODE button.
- ④ The saved value is used until the next change.

(2) Items

① Results sheet selection

This option is used to select the type of results sheet.



: The results is printed on the custom - made test results sheet.



: The results is printed on the A4 - sized paper.

② Weight adjustment

You can adjust the measured weight. If the clothes or jewelry the subject is wearing during the testing significantly adds to the weight, use this option to deduct some weight from the default reading of the scale. (permissible range of offset value : +5kg~-5kg, unit:0.1kg)

③ Mode



: It is for medical purpose. The measurement duration is 1 minute and reactance is not measured.



: It is for research purpose. The measurement duration is 2 minute and reactance is measured.

3. DATABASE

Press the DATABASE key on the Keypad to bring up the database screen as shown below.

No.	I.D.	Date	Time	Height	Weight	Print	Delete
1	1	2005/09/01	11:54	178.0cm	75.3kg	Print	Delete
2	123	2005/09/01	11:34	170.6cm	55.1kg	Print	Delete
3	2580	2005/09/01	14:33	162.0cm	58.9kg	Print	Delete
4	630213	2005/08/30	13:27	160.0cm	67.5kg	Print	Delete
5	OHSECHANG	2005/09/01	11:19	171.7cm	68.1kg	Print	Delete
6	OSC	2005/09/01	11:45	171.8cm	68.0kg	Print	Delete
7	WILLY	2005/09/01	13:09	170.0cm	64.4kg	Print	Delete

COPY : Press SETUP Backup/Restore : Press DATABASE

On the top right of the screen, the current number of subjects and the total number of subjects that can be saved are displayed. To move through the database screen, use the direction keys.

(1) I.D. search

The cursor is located in the I.D. search field. Type a key word or a set of characters in the text field and press ENTER to search the matching data.

Example) '12' + ENTER : Find all I.D.s including '12'.

ENTER : Displays the entire database in the InBody720.

(2) Print

To print out the test result of a particular person, move the cursor to the record of that person. Press the direction key(▶) to move to 'Print' and then press ENTER.

(3) Delete

To delete the record of a particular person, move the cursor to the record of that person. Press the direction key(▶) to move to 'Delete' and then press ENTER. To delete the entire records existing, select the option of 'initialize history' in the 'Others' from the Setup menu.



The deleted data can not be restored.

CAUTION

(4) Copy

You can easily copy the test results in the USB storage device. Move the cursor to the record of a particular person you want to copy and press SETUP. If you would like to copy the entire database in the InBody720, move the cursor to the I.D. search field and then press SETUP.



Contact InBody or an authorized distributor for information of the compatible USB storage devices with the InBody720.

(5) Backup/Restore

You can easily back up or restore all the data saved in the InBody720 using an USB storage device. Press DATABASE at the database screen. When a window pops up, press 1 for the Backup and 2 for the Restore. Press EXIT/MODE to quit. Users can not use the backup files. It is only used for the result restoration when necessary.



Periodically back up the results in case of user's misuse or disorder of the equipment.



Note that the previous data in the InBody720 is automatically deleted when restoring new data from USB.



An individual can save 10 test results. It is possible to save up to 7,000 results in total.

4. Modification Example

(1) When using A4 size paper for result sheet

- ① Press the SETUP button.
- ② Move to 'Result Sheet' using the direction buttons (▲▼).
- ③ Move to 'Mode' using a direction button (▶).
- ④ Select 'Built-in' using the direction buttons (▲▼).
- ⑤ After pressing EXIT/MODE button 3 times, the screen asking whether you want to save modified settings will pop up. Press 'Enter' button to quit setup. The analysis results will be printed out on the A4 paper. Use the standard A4 paper only.

(2) When using the printed result sheet

- ① Press the SETUP button.
- ② Move to 'Result Sheet' using the direction buttons (▲▼).
- ③ Move to 'Mode' using a direction button (▶).
- ④ Select 'Printed' using the direction buttons (▲▼).
- ⑤ After you press EXIT/MODE button 3 times, the screen asking whether you want to save modified setting will pop up. Press 'Enter' button to quit setup. Use the printed result sheet provided by InBody only.

Chapter 4 Problems and Solutions

1. Error Messages

2. Troubleshooting

3. Frequently Asked Questions (FAQs)

4. Customer Service Information

1. Error Messages

The InBody720 displays the following error messages to warn the user of the problems it runs up against during operations and to guide the users to take steps. The following is the most common error messages and the steps to handle the corresponding errors.

“After removing any objects on InBody720, press “Enter” button.”

This message comes up when weight is detected from the base frame between the power-on and the completion of boot-up process. Remove the object from the base frame and restart the equipment.



“Enter personal data correctly.”

This message appears when the value for age or height of the subjects is out of the permissible range for these data. Check your entry again. As for the permissible range of each data, refer to the “Chapter 2, section 5 : Personal Profile.”

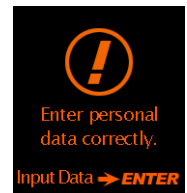

“Wipe hands and feet using electrolyte tissue.”

This message fires up when the posture of the subject is not appropriate or the subject’s palms or soles are too dry or have too much hard skin, making it impossible to start the test. Correct the posture of subject or wet his/her palms and soles with electrolyte tissues, before reinitiating the test.



2. Troubleshooting

This section lays out the order of steps you have to take for each particular problem, on the assumption that you have some basic knowledge on how to operate the InBody720. If you still have the problem after taking the following steps, contact our customer service representatives listed in the warranty certificate appended to the end of this user's manual.

The equipment doesn't seem to run, even after the power is on.

(In normal situation, the LCD is turned on.)

Cause 1 The plugs are not pushed all the way through an electrical outlet.

Step 1 Push the plug all the way through the electrical outlet.

Cause 2 Power bar is not turned on (when using a power bar) or the power doesn't come on to the power bar.

Step 2 Check if the power comes on to the power bar and an electrical outlet the power bar is connected to.

Cause 3 Fuse blows.

Step 3 Check to see if the fuse in a fuse holder is functioning. If necessary, replace the blown fuse with a spare fuse. The InBody720 comes with 4 spare fuses or you can purchase at an electrical store.

Weight comes up as a negative number (-) or is widely different from the reasonably anticipated weight of the subject.

(Usually the weight displayed on the InBody720 is close to what the subject knows.)

Cause 1 This happens when the boot-up was not completed normally.

Step 1 Initialize the weight to zero during the boot-up. If there is an object on the base frame, the initialization process doesn't take place normally, preventing the normal weighing process from happening. Remove an object on the base frame and make sure there is nothing on the base frame and then restart the InBody720.

The measurements don't seem right.

(When the measurements seem too high or too low)

- Cause 1** The subject loses contact with the electrodes or fails to maintain the recommended posture during the testing.
- Step 1** Refer to the “Chapter 2, section 6. Proper posture” to correct the subject's posture and maintain the recommended posture until after the testing is finished.

Results sheet doesn't print.

(Normally when the testing is done, the results sheet prints out automatically.)

- Cause 1** The printer is out of A4-sized paper and the printer has the warning LED light on or displays the message saying it is out of paper.
- Step 1** Check if there is A4-sized paper in paper tray.
- Cause 2** The cables to the printers are not connected properly.
- Step 2** Check if the printer cables are connected to the InBody720 and to the power outlets. If any problem with the cables causes a connection failure, replace or fix the cables.
- Cause 3** Paper gets stuck inside a printer, with the warning LED on or the printer displaying a message reporting paper jam.
- Step 3** Check to see if paper is jammed in the printer.
- Cause 4** A wrong printer is selected in the printer settings, or the number of results sheet to be printed is set at “none”.
- Step 4** Check if the model number of printer currently in use is selected in the printer settings of InBody720 and if the printer is compatible with the InBody720.

The prints are off balance.

(The prints don't normally go off balance to one direction.)

- Cause 1** Coordinates of objects in the results sheet are placed in wrong locations.
- Step 1** Refer to “Chapter 3, section 1: Setup Menu” for hands-on explanation on how to move the coordinates of objects on results sheet and fiddle with them.



A problem arises when the orientations of printing set in the printer doesn't correspond with that of the InBody720. Refer to the user's manual of the printer to change the orientations of printing in the printer. The orientation of printing set in the InBody720 is portrait.



As error message, the misprints, and burnt-out fuse are something that technical service representatives can examine in the process of troubleshooting, keep them in a safe spot or keep records of them.

3. Frequently Asked Questions(FAQs)

As InBody720 is used in clinical environment, we receive many clinical questions involving InBody720, which has nothing to do with malfunctions of the equipment itself. Before you ask us clinical questions, read the following list of frequently asked questions and the answers to them. If you have any clinical questions regarding InBody720, contact us at the following email address:

E-mail: info@inbody.com (Clinic Questions & Answers)

Do I have to take off socks or pantyhose?

Socks or pantyhose block the electric current used to analyze the body composition, making an accurate analysis impossible. Bare skin should be in direct contact with the electrodes.

Who should not use InBody720 or who cannot have body composition analyzed?

- Subjects who have cardiac pace maker or other electric medical devices embedded in the body must not be tested using InBody720.
- Those who may experience difficulty being tested are: the subject who weighs less than 10kg or over 250kg or who is shorter than 95cm in height is out of the permissible range of measurements and might see the accuracy of body composition analysis drop.
- Testing is difficult with the children who cannot hold on to the hand or foot electrode during testing, or amputees or elderly who have trouble standing still during testing.
- Subjects who have metallic core embedded in the body may see the bodily conductivity affected by the metallic element. However, the InBody720 retrieves the body composition information from various parts of body, reducing the probability of erroneous analysis significantly.

Can an amputee or people who cannot stretch their hands or feet to the electrode be tested?

It is impossible to test people who cannot contact the electrode. InBody has a lineup of products that conduct body composition analysis on the subjects in bed, without having to get subjects out of bed during the tests. For more information on this product lineup, contact InBody.

Is the electric current harmful to the body?

The physiological electric impedance method uses very subtle current that is not harmful to the human body (refer to the product specifications). Its safety is proven through the certifications from Korea and Europe. Many medical institutions are using the InBody720.

Can the jewelry or other metallic wear affect the testing?

The ideal test methodology is where the subject doesn't wear anything metallic. As the weight of clothes and other wear affects the results of body composition analysis, it is strongly recommended to take off any heavy clothing or metallic wear. Except for the weight, jewelry doesn't exact any effects on the body composition analysis, as the contact points with InBody720 are hands and feet that are usually free of jewelry.

How often do I have to get body composition test?

Subjects who are undergoing treatments that may affect the body composition (e.g. exercise, obesity, rehabilitation, hormone treatment) are strongly recommended to have the body composition analysis done every two or four weeks.

What are the requirements for the subject for accurate testing?

Keep in mind the following requirements for accurate body composition analysis.

- Do not have a meal before testing.
- If you had a meal, wait 2 hours before having a test.
- Go to bathroom before testing.
- To get closer to pure weight, wear light clothes and remove jewelry or other wear before testing.
- Do not exercise or have a bath before a test.
- Stand up for 5 minutes before tests.
- Do not sit down and stand up right before a test.
- Do not have a test while taking diuretic.
- Avoid having a test during period.
- Enter the exact height.
- Keep the room temperature between 20 °C and 25 °C. Warm up yourself for 20 minutes before a test in winter.

Do I have to use electrolyte tissue? Can I just use wet cloth?

The electrolyte tissue provided by the InBody720 is specially designed for optimal testing, as opposed to other wet cloth. Always use the electrolyte tissue for accurate testing.

How do you go about measuring the circumference of the body?

InBody720 uses the partial measurements to determine the distribution of muscles, from which the InBody720 factors in the body shape to map out the distribution of fat. This is how the InBody720 calculates the size and circumferences of each part of the body.

How reliable is WHR value?

The WHR value obtained from body composition analysis using InBody720 has the correlation rate of 0.9 in comparison with the real value. The correlation rate is a little bit lower than that of other values, but the WHR value saves the user from measuring the circumferences of each body part with tape measures and has a higher rate of usability in the system. WHR is one of the values that only InBody720 provides as impedance equipment and that are not found elsewhere.

4. Customer Service Information

Corporate agents of InBody720 and addresses are listed below.
Contact us for assistance or more information about InBody720.

InBody Co., Ltd. [HEAD OFFICE]

InBody Bldg., 54, Nonhyeon-ro 2-gil, Gangnam-gu, Seoul 135-960 KOREA
TEL: +82-2-501-3939
FAX: +82-2-578-2716
Website: <http://www.inbody.com>
E-mail: info@inbody.com

InBody [USA]

13850 Cerritos Corporate Dr., Unit C, Cerritos, CA 90703, USA
TEL: +1-323-932-6503
FAX: +1-323-952-5009
Website: <http://www.inbodyusa.com>
E-mail: info@inbodyusa.com

InBody Japan Inc. [JAPAN]

Tani Bldg., 1-28-6, Kameido, Koto-ku, Tokyo 136-0071 JAPAN
TEL: +81-3-5875-5780
FAX: +81-3-5875-5781
Website: <http://www.inbody.co.jp>
E-mail: inbody@inbody.co.jp

EU Representative. [EUROPE]

DongBang Acuprime.
1 Forrest Units, Hennock Road East, Marsh Barton, Exeter EX2 8RU, U.K
TEL: +44-1392-829500
FAX: +44-1392-823232
Website: <http://www.inbody.com>
E-mail: info@acuprime.com

Biospace China. [CHINA]

904, Xing Di Plaza, No. 1698 Yishan Road, Shanghai, 201103, CHINA
TEL: +86-21-64439738, 9739, 9705
FAX: +86-21-64439706
Website: <http://www.biospacechina.com>
E-mail: info@biospacechina.com

Australian Sponsor. [AUSTRALIA]

Emergo AUSTRALIA. Level 20, Tower II, Darling Park, 201 Sussex Street, Sydney, NSW 2000, AUSTRALIA
TEL: +61-2-9006-1662
FAX: +61-2-9006-1010
Website: <http://www.emergogroup.com>
E-mail: Sponsor@emergogroup.com

Chapter 5 Consumables

1. Consumables

2. Options

1. Consumables

The following diagram and specifications describe the properly functioning electrolyte tissue. If you find any abnormality or defects with the tissue, stop using it and contact the InBody head office or one of the distributors to get it replaced with the normal tissues.

A. Electrolyte tissue

The specifications of electrolyte tissue are:

Expiration date	The date on the box
Packing Material	PET+AL+PE
Packing Size	100mm x 75mm
Tissue Size	205mm x 185mm
Quantity	300 packs per box
Manufacturer	InBody Co., Ltd.

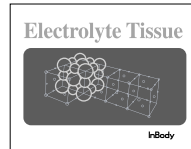

This electrolyte tissue is disposable. Do not reuse it as it may yield infection.



This electrolyte tissue has a disinfecting effect.

B. Results sheet

Results Sheet size	A4(210mmX297mm)
Number of Sheets	1000sheets/1box
Printed Condition	4colors
Manufacturer for	InBody Co., Ltd.

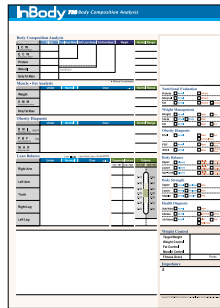

(Basic Results Sheet For Adult)

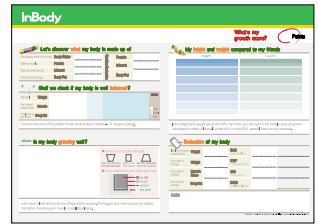

(Basic Results Sheet For Child)

C. Fuse

Fuse holder is located inside the fuse socket, which is at the bottom of the back of the InBody720.

Type	Fast-Acting
Rated current	2.5A
Rated voltage	250V

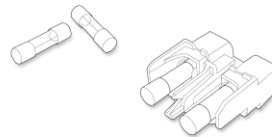

Turn off the equipment, when changing fuses.

2. Options

InBody provides optional devices to make the operation of InBody720 more efficient and convenient. For more information, contact the head office or authorized distributors of InBody.

A. Lookin' Body

Lookin'Body is a database management software, which stores the measurement results generated by InBody720. In addition, Lookin'Body keeps track of the measurement history of subjects as well as illustrating the results by period and category, with a lot of visual explanations. Lookin'Body will help you provide more valuable consultation to your clients.

System requirements for installation are:

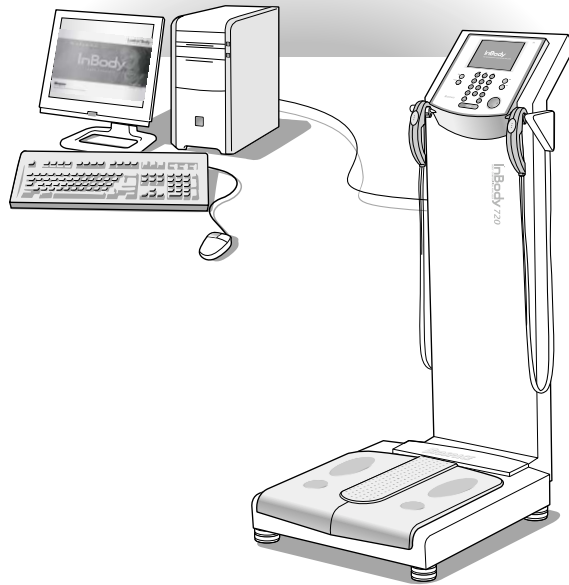

Operating System	Windows2000/XP or Compatible
CPU	Intel PentiumIII 700Mhz or Higher, IBM-PC or Compatible
HDD	Intel Pentium III 700MHz or higher IBM-PC or Comaptiable
Hard disk	Minimum 800MB
Main Memory(RAM)	256MB or Higher Recommended
Graphic Devices	Supporting 1024X768 or Resolution and 16bit Color or Higher Recommended
Input Devices	Keyboard, Mouse
Communications Port	Serial Port(RS-232C), USB, LAN

Appendix

1. More About InBody720

2. Classifications

3. Specifications

Manufacturers Warranty

1. More About InBody720

A. Principles of Bioelectrical Impedance Analysis (BIA)

Bioelectrical Impedance Analysis (BIA) is based on the fact that organs and tissues of human body work as semi-conductor or a non-conductor electronically. In general, 50~60% of human body is comprised of water, which functions as a conductor.

The traditional holistic-BIA method assumes that human body is one cylinder and then assesses the impedance of the body as shown in the following figure.

When the area is A and the length is L for a cylinder, we can use the following formula to find the impedance of the cylinder.

$$Z = \rho \frac{L}{A}$$

(ρ = resistivity, value of unique resistance of a particular type of material)

Multiple the length (L) to each side and simplify the formula as shown below.

$$V = \rho \frac{L^2}{Z}$$

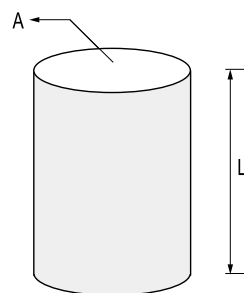

According to this expression, if we know the L and the impedance value, we get the volume.

That is to say, if we know the height of the human body (acting as a conductor), and know the impedance value, we can get the volume of body water. Here, the volume of water in the cylinder represents the volume of body water and the length of the cylinder represents subject's height. Therefore, the two directly used variables in body composition analysis are impedance and height.

The principle of InBody720's body composition analysis is explained as the following;

The volume of body water, an electrolyte, is calculated first with measured impedance value. Then, we can get the value of fat free mass using the volume of body water. Fat mass is determined by direct measurement or deducting the fat free mass from entered weight.

Height should be entered by user. Weight can be directly measured on InBody720 or entered.

B. Core technology

The body composition analyzer InBody720 is precision clinical diagnostic tool featuring the world-leading technology of InBody. The advanced technology used in the InBody720 is recognized both in Korea and abroad, as InBody obtained CE for exports to Europe and signed a technology royalty agreement with Yamato of Japan. The key features of the InBody720 built on the advanced technologies patented both in Korea and abroad.

Multi-frequency Measurement

The traditional body fat measurement tools using the impedance uses one, single frequency at 50kHz to determine the impedance of the human body. On the other hand, the precision body composition analyzer InBody720 emits multitude of frequencies including 1kHz, 5kHz, 50kHz, 250kHz, 500kHz, 1MHz, using the multi-frequency technology that is a way more advanced than the single-frequency technology. The multi-frequency technology separates the intracellular water from the extracellular water, minimizing the probability of errors

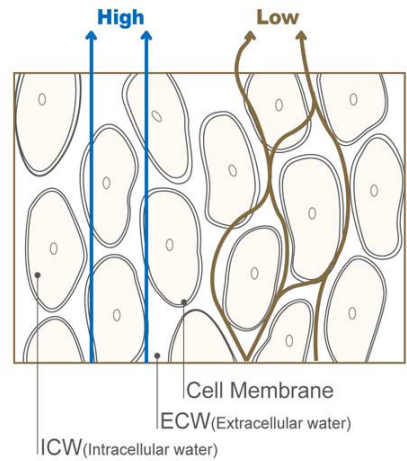

caused by individual variations in the distribution of the body water or changes of it over the period. The InBody720 can be reliably used on the subject suffering from diseases and is capable of diagnosing diseases such as edema.

The frequency of 5kHz, 50kHz and 250kHz are used to measure the resistance and reactance, components of body impedance, enabling it to measure the body water accurately. This technology, exclusive to InBody, overcomes the limitations with the body composition analysis.

Tetrapolar 8-Point Tactile Electrode

The traditional way was to attach a tape such as ECG electrode to the skin and connect the tape to the impedance reader. The biggest problem with this methodology is a low level of accuracy, because the measurements vary with the locations of electrodes and how firmly the electrodes are attached. The body composition analysis InBody720 uses 8-point tactile electrodes method that is easy to implement and is known to maintain consistency regardless of variations in the test environment. The patented technology in the InBody720 takes the accuracy of body composition analysis.

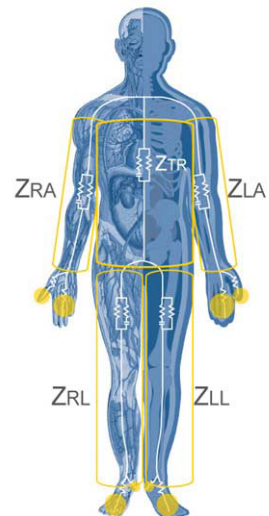

2. Classifications

- Type of protection against electric shock : Class I
- Type of the applied parts : BF Type
- Degree of protection against water infiltration : IPXO
- EMC Immunity : Level A
- EMC Emission : Level A
- Equipment not suitable for use in the presence of flammable mixture

3. Specifications

Measurement Method	Direct Segmental Multi-frequency Bioelectrical Impedance Analysis Method ;DSM-BIA Method
Measurement Items	Impedance(Z) 30 Impedance Measurements by Using 6 Different Frequencies (1kHz, 5kHz, 50kHz, 250kHz, 500kHz, 1000kHz) at Each 5 Segments (Right Arm, Left Arm, Trunk, Right Leg, Left Leg)
	Reactance(Xc) 15 Impedance Measurements by Using 3 Different Frequencies (5kHz, 50kHz, 250kHz) at each 5 segments (Right Arm, Left Arm, Trunk, Right Leg, Left Leg)
Electrode Method	Tetrapolar 8-Point Tactile Electrode System
Body Composition Calculation Method	No Empirical Estimation
Outputs	Intracellular Water, Extracellular Water, Protein, osseous/non-osseous Mineral, Body Fat Mass Skeletal Muscle Mass. Soft Lean Mass, Fat Free Mass, Weight BMI, Percent Body Fat, Waist-Hip Ratio(WHR) Segmental Soft Lean Mass, The Ratio of Segmental Soft Lean Mass Edema, Segmental Edema Visceral Fat Area(Growth Chart for the children under 18 of age) Nutritional Evaluation(Protein, Mineral, Fat) Body Balance, Body Strength, Health Diagnosis Target Weight, Weight Control, Fat Control, Muscle Control, Fitness Score Obesity Degree, BCM, BMC, BMR, AC, AMC Body Composition History(Results of 10 measurement) Impedance of Each Segments & Frequencies
Applied Rating Current	90 μ A(1kHz), 400 μ A(others)
Power Consumption	60VA
Power Source	100-240V~, 50/60 Hz
Display Type	640 \times 480 Color TFT LCD
External Interface	RS-232C 3EA, USB Host 2EA, Ethernet(10/100 Base-T) 1EA, IEEE1284 (25pin parallel) 1EA
Compatible Printer	Laser/Inkjet Printer (with PCL 3 or above, the printers recommended by InBody)
Dimensions	20.4(W) \times 34.3(L) \times 47.2(H) : inch (520(W) \times 870(L) \times 1200(H) : mm)
Machine Weight	99lbs.(45kg)
Measurement Duration	Less than 1 min. 30 sec. (Less than 2 min. 30 sec. for research purpose mode)
Operation Environment	10 ~ 40 $^{\circ}$ C, 30 ~ 75%RH, 70 ~ 106kPa
Storage Environment	-20 ~ 70 $^{\circ}$ C, 10 ~ 95%RH, 50 ~ 106kPa(No Condensation)
Weight Range	22 ~ 551lbs.(10 ~ 250kg)
Age Range	3 ~ 99years
Height Range	3ft. 1.4in. ~ 7ft. 2.6in.(95 ~ 220cm)

* Specifications are subject to be changed without prior notice.

Manufacturers Warranty

Product :
Serial Number :
Purchase Date :
Institute Name :

InBody Co., Ltd. [HEAD OFFICE]

InBody Bldg., 54, Nonhyeon-ro 2-gil, Gangnam-gu, Seoul 135-960 KOREA

TEL: +82-2-501-3939 FAX: +82-2-578-2716

Website: <http://www.inbody.com>

E-mail: info@inbody.com

1. InBody guarantees that the product has been approved with the qualified test procedure under the severe condition.
2. The one year factory warranty begins on the day of purchase.
3. During the one - year warranty period, InBody remedies any original defect in material or workmanship.
4. The following defects or malfunctions will not be covered under the one year warranty :
 - Any defect caused by user's fault.
 - Any defect or damage caused by not following the instructions described in the user's manual.
 - Any defect or damage caused by natural disasters (storm, flood, earthquake, etc.)
 - Any defect or damage caused by disassembly of InBody720 or by modifying internal parts or program by unauthorized person.
5. An extended warranty may be purchased by executing an extended warranty contract after the initial warranty period.
6. No return is allowed after a product is opened. The proof of purchase must be accompanied before requesting service.
7. Please contact an authorized service for any service calls.